

FMR P-positive



Future Mill Series for Mold Making

■ Stable Clamping System

Wide and curved clamping area and flat anti-rotating area prevent rotation and damp vibration to provide stable machining and increase productivity.

■ Enhanced Rigidity

P-positive relief angle (11°) exhibits higher rigidity and excellent machining for high hardness mold steel and heat-resistant alloy.

■ Wide Application Range

A wide line up of grades and chip breakers for all machining

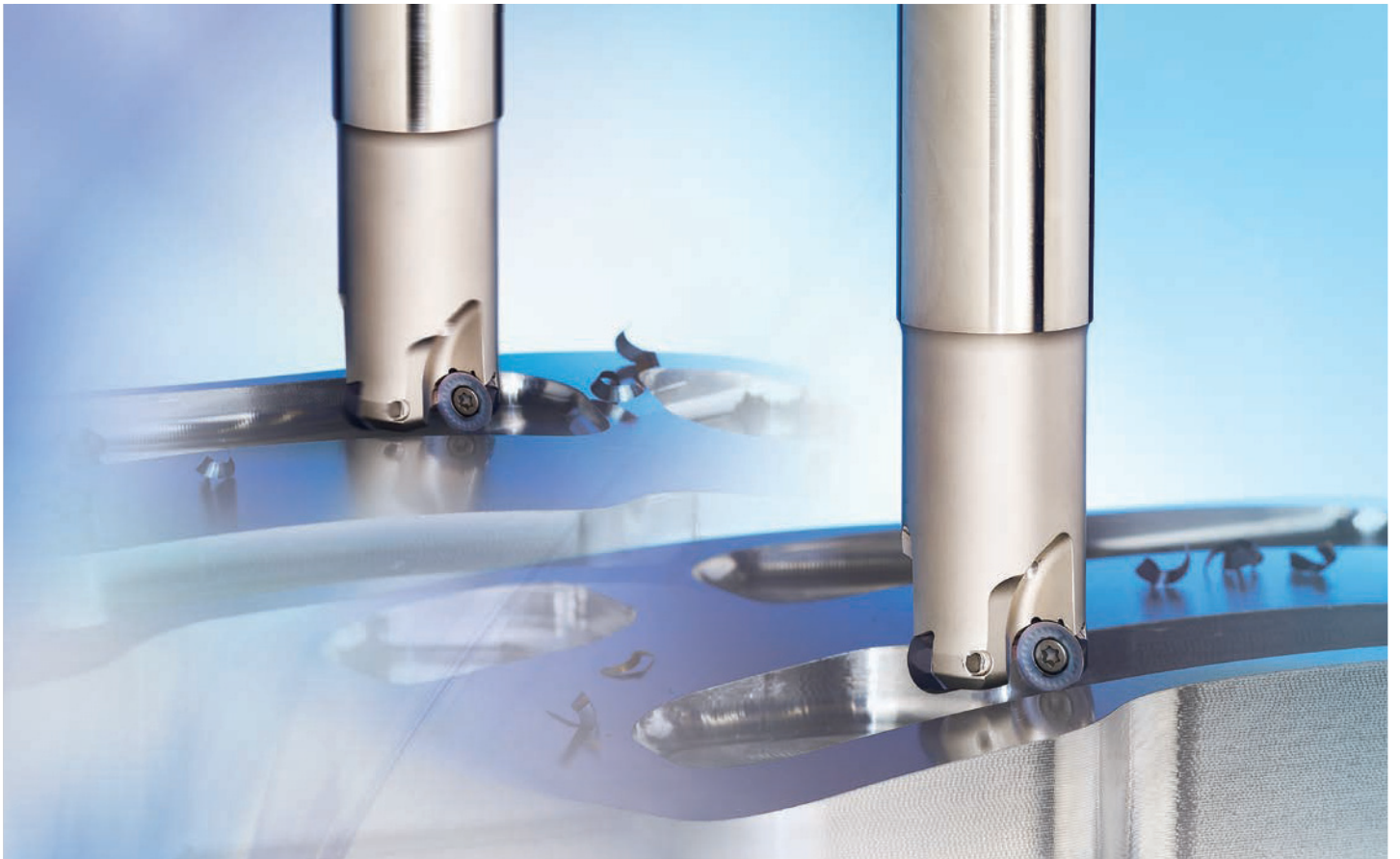

Rough Milling Tool for Mold Making of High Hardness Mold Steel and Heat-resistant Alloy



Insert



Shank



Cutter

There is a growing interest in fashioning cutting tools for mold making that can be both cost effective and capable of excellent delivery. In its current state, the mold making industry has a range of applications spanning shouldering, facing, slotting to plunging. The downside of all these assorted tools is the risk of compromising productivity and cost efficiency if they were to be replaced individually. It is with this in mind that the FMR P-positive comes to the rescue because of its purpose built capacity to work through high hardness mold steel and heat-resistant steel in rough milling. This unique feature is what distinguishes it from the existing FMR D-positive.

The FMR P-positive is available in most applications. In case of dealing with cut depths of less than 1mm depth, cutting angle is formed under 15° for high feed milling. It also has high depth cut capabilities of up to half the insert size (4~10mm). High depth cut and high feed machining allow for increase in productivity. That is because high feed tools form thinner chips in the same feed condition, which helps reduce cutting force. The FMR P-positive would be an ideal choice, particularly when you want to improve productivity or use low horse power.

The New FMR P-positive inserts are a comprehensive cost effective device. It features reinforced rigidity by applying a relief angle of 11°. Relief surfaces of 18° have been included to prevent interference by feeds. 4 to 8 out of the relief surfaces are isotropic designed to provide a large relief angle around the circumference, to prevent anti-rotating often resulting from machining with the R-type insert.

In mold making, a shank type that has a long body of a large aspect ratio over 2D is commonly used. The large aspect ratio is vulnerable to tool vibration even under low cutting load that may even result in tool breakage in extreme cases. To resolve this problem, the FMR P-positive forms a negative axial rake angle. With the use of the negative angle, both wear on rake surfaces and the contact area on workpieces are reduced to minimize tool vibration.

The FMR P-positive also results in increased effective diameter and faster cutting speeds (In case of Ø32-6R, 1.6 times faster), and a wider turning radius. All of these will lead to stable machining right from the onset even when dealing with a ratio of 6D in order to finally deliver higher productivity.

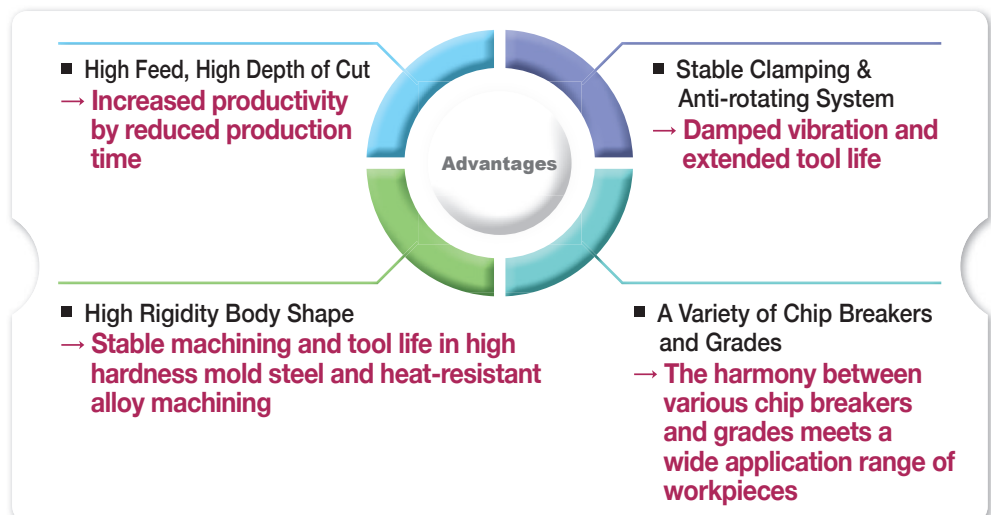

➤ Features

- P-positive relief angle (11°) ensures high rigidity and high machinability in die steel and high-resistant alloy machining.
- Flat clearance face of insert prevents interference and revolution while machining.
- Optimal grades and chip breakers for various workpieces

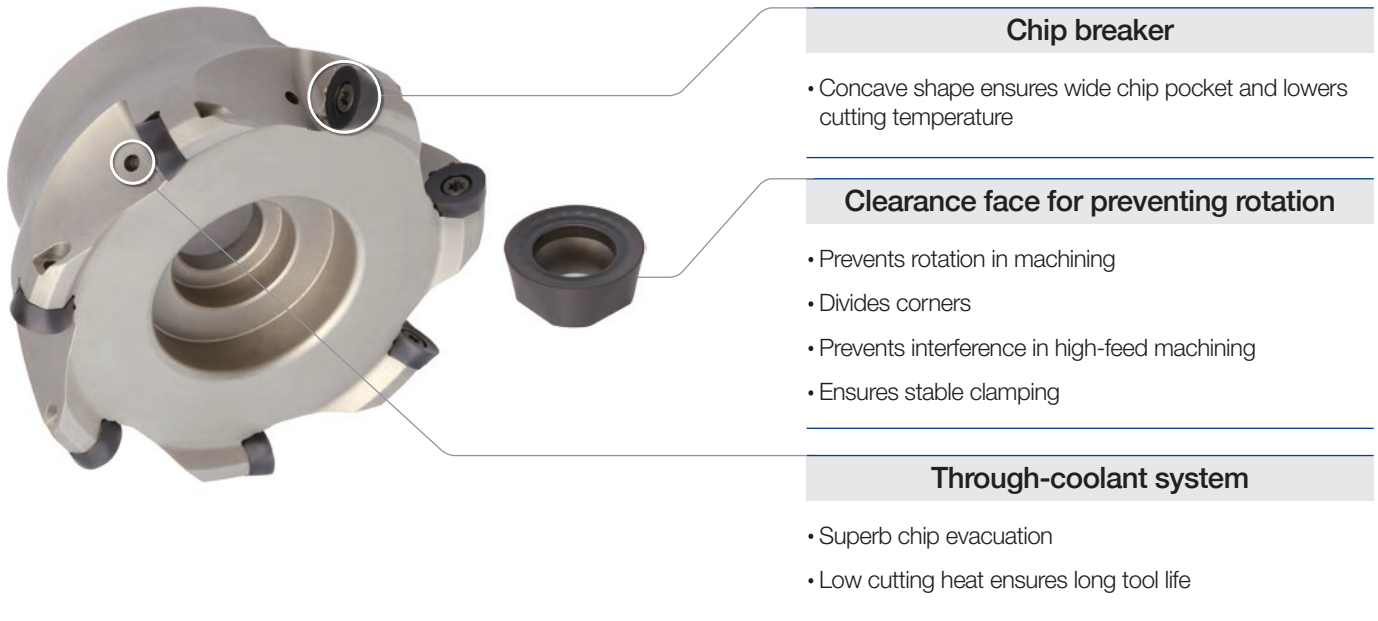

➤ Usage and Features of Chip Breakers

Chip breaker	Cutting edge	Applications	Features
MA		Aluminum machining	Optimal cutting edge for aluminum machining and buffed surface ensure high machinability
ML		Titanium & Inconel machining	Excellent results in titanium & Inconel machining thanks to a high hardness cutting edge and the chip breaker reducing the cutting load
MF		Fine finishing	Chip breaker for low cutting resistance enables fine finishing
MM		General machining	Optimal for general machining
None C/B		Super hard material machining	Optimal for high hardness die steel and heat resistant alloy

FMR P-positive

⇒ Recommended Cutting Conditions



Workpiece	Hardness	Grades	Cutting conditions				Chip breaker						
			vc (m/min)	fz (mm/t)	ap (mm)	ae (mm)	MA	ML	MF	MM	None C/B 1 2		
P	Low carbon steel	HB80~180	PC5400	100~250	0.12~0.70	0.3~6.0	0.7D~0.1D	-	-	●	○	-	-
	High carbon steel	HB180~280	PC5400	100~220	0.12~0.70	0.3~6.0	0.7D~0.1D	-	-	●	○	-	-
	Low alloy steel	Under HRC27	PC3600	180~290	0.20~0.60	0.3~6.0	0.7D~0.1D	-	-	-	●	○	-
			PC5400 PC5300	100~200	0.20~0.60	0.3~6.0	0.7D~0.1D	-	-	-	●	○	-
	Low pre-hardened steel	HRC20~50	PC3600	130~250	0.30~0.50	~0.5	0.7D~0.1D	-	-	-	-	●	○
			PC2510 PC5300	50~150	0.30~0.50	~0.5	0.7D~0.1D	-	-	-	-	●	○
	High alloy steel	Under HRC27	PC3600	130~250	0.30~0.50	~0.5	0.7D~0.1D	-	-	-	●	○	-
PC5300			100~220	0.30~0.50	~0.5	0.7D~0.1D	-	-	-	●	○	-	
High pre-hardened steel	HRC20~48	PC2510 PC5300	50~150	0.30~0.50	~0.5	0.7D~0.1D	-	-	-	-	●	○	
M	Stainless steel	Under HB270	PC5300 PC5400	100~150	0.20~0.60	0.3~6.0	0.7D~0.1D	-	-	○	●	-	-
K	Gray cast iron, Ductile cast iron	Under 350MPa	PC5300	120~210	0.20~0.60	0.3~6.0	0.7D~0.1D	-	-	○	●	-	-
N	Aluminum	-	H01	300~800	0.30~0.60	0.3~6.0	0.7D~0.1D	●	-	-	-	-	-
S	Heat resistant alloy	Fe	HRC20~30	PC5300 PC5400	35~60	0.30~0.50	~0.5	0.7D~0.1D	-	●	○	-	-
		Ni or Co	HRC40~45	PC5300 PC5400	30~50	0.30~0.50	~0.5	0.7D~0.1D	-	●	○	-	-
	Titanium	HRC35~45	PC5300 PC5400	40~70	0.30~0.50	~1.5	0.7D~0.1D	-	●	○	-	-	
H	High hardened materials	Over HRC50	PC2505 PC2510	30~50	0.30~0.50	~0.5	0.7D~0.1D	-	-	-	-	●	○

※ Recommended chip breaker : ● First ○ Second

⇒ Feed per Tooth According to ap(fz, mm/t)

(mm)

Insert	Insert size(d)	Feed per tooth according to ap							
		ap=1	ap=2	ap=3	ap=4	ap=5	ap=6	ap=8	ap=10
RPMT08	8	0.30	0.22	0.18	0.15	-	-	-	-
RPMT10	10	0.40	0.28	0.25	0.20	0.12	-	-	-
RPMT12	12	0.60	0.45	0.35	0.30	0.25	0.20	-	-
RPMT16	16	0.65	0.45	0.40	0.32	0.30	0.28	0.23	-
RPMT20	20	0.70	0.50	0.42	0.35	0.32	0.29	0.25	0.22

➔ Application Examples



Alloy steel (E355C Heat treatment, HRC38~40)

- Cutting conditions $vc(m/min) = 250$, $fz(mm/t) = 0.6$, $ap(mm) = 1$, wet
- Tools

Insert	RPMT1204M0E-MF(PC5300)
Holder	FMRS4032HRP-3L25



➔ 90% longer tool life than competitor

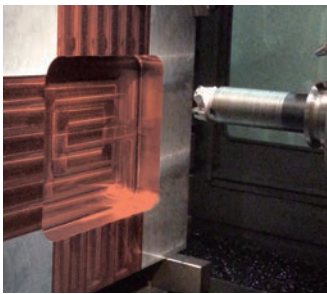

Low pre-hardened steel (40CrMnNiMo8-6-4 Heat treatment, HRC30~45)

- Cutting conditions $vc(m/min) = 178$, $fz(mm/t) = 0.72$, $ap(mm) = 1.5$, dry
- Tools

Insert	RPMT1606M0S-MM (PC5300)
Holder	FMRCM5063HRP-4



➔ 50% longer tool life than competitor

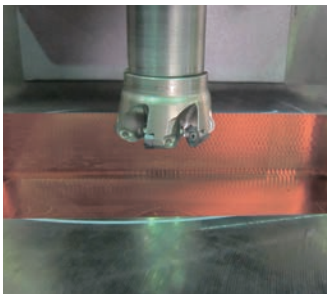

Low pre-hardened steel (C55E4, HRC28~33)

- Cutting conditions $vc(m/min) = 178$, $fz(mm/t) = 0.74$, $ap(mm) = 0.8$, dry
- Tools

Insert	RPMT1204M0E-MF (PC5300)
Holder	FMRCM4063HRP-6



➔ 20% longer tool life than competitor

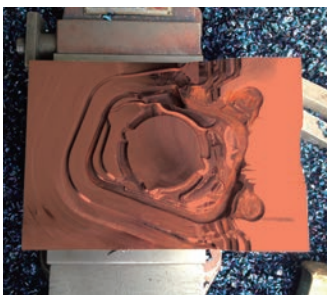

High pre-hardened steel (X40CrMoV5-1, HRC50~52)

- Cutting conditions $vc(m/min) = 50$, $fz(mm/t) = 0.15$, $ap(mm) = 4.0$, dry
- Tools

Insert	RPMW1204M0S1 (PC5300)
Holder	FMRS4032HRP-3L25



➔ 30% longer tool life than competitor

FMR P-positive

Available Inserts

(mm)

Designation	Usage	Cutter	Coated					Uncoated	Dimensions(mm)			Configuration	
			PC2505	PC2510	PC3600	PC5300	PC5400	H01	d	t	d ₁		
RPCT	10T3M0-MA	Al machining	3000 type	-	-	-	-	-	●	10	3.97	4.0	
	1204M0-MA	Al machining	4000 type	-	-	-	-	-	●	12	4.76	4.5	
	1606M0-MA	Al machining	5000 type	-	-	-	-	-	●	16	6.35	5.5	
	2007M0-MA	Al machining	6000 type	-	-	-	-	-	●	20	7.00	7.0	
RPET	0803M0E-ML	Titanium & Inconel machining	2500 type	-	-	-	●	●	-	8	3.18	3.4	
	10T3M0E-ML	Titanium & Inconel machining	3000 type	-	-	-	●	●	-	10	3.97	4.0	
	1204M0E-ML	Titanium & Inconel machining	4000 type	-	-	-	●	●	-	12	4.76	4.5	
	1606M0E-ML	Titanium & Inconel machining	5000 type	-	-	-	●	●	-	16	6.35	5.5	
	2007M0E-ML	Titanium & Inconel machining	6000 type	-	-	-	●	●	-	20	7.00	7.0	
RPMT	0803M0E-MF	Low cutting resistance machining	2500 type	-	-	●	●	●	-	8	3.18	3.4	
	10T3M0E-MF	Low cutting resistance machining	3000 type	-	-	●	●	●	-	10	3.97	4.0	
	1204M0E-MF	Low cutting resistance machining	4000 type	-	-	●	●	●	-	12	4.76	4.5	
	1606M0E-MF	Low cutting resistance machining	5000 type	-	-	●	●	●	-	16	6.35	5.5	
	2007M0E-MF	Low cutting resistance machining	6000 type	-	-	●	●	●	-	20	7.00	7.0	
RPMT	0803M0S-MM	Stronger cutting edge	2500 type	-	-	●	●	●	-	8	3.18	3.4	
	10T3M0S-MM	Stronger cutting edge	3000 type	-	-	●	●	●	-	10	3.97	4.0	
	1204M0S-MM	Stronger cutting edge	4000 type	-	-	●	●	●	-	12	4.76	4.5	
	1606M0S-MM	Stronger cutting edge	5000 type	-	-	●	●	●	-	16	6.35	5.5	
	2007M0S-MM	Stronger cutting edge	6000 type	-	-	●	●	●	-	20	7.00	7.0	
RPMW	0803M0E1	High hardness material machining	2500 type	-	-	●	●	●	-	8	3.18	3.4	
	10T3M0E1	High hardness material machining	3000 type	-	-	●	●	●	-	10	3.97	4.0	
	1204M0S1	High hardness material machining	4000 type	-	-	●	●	●	-	12	4.76	4.5	
	1204M0S2	High hardness material machining (Stronger cutting edge)	4000 type	-	-	-	●	●	-	12	4.76	4.5	
	1606M0S1	High hardness material machining	5000 type	-	-	●	●	●	-	16	6.35	5.5	
	2007M0S1	High hardness material machining	6000 type	-	-	●	●	●	-	20	7.00	7.0	

※ ML Chip breaker inventory is being prepared at the moment and pre-orders can be made in advance.

Parts

Type	Screw	Wrench	Wrench	Holder Dia.
2500 type	FTNA0305	TW09S	-	Ø17
	FTNA0306			Ø18~Ø40
3000 type	FTGA03507	TW15S	-	Ø25~Ø26
	FTGA03508			Ø32~Ø66
4000 type	FTKA0408	TW15S	-	Ø25~Ø26
	FTKA0410			Ø32~Ø100
5000 type	FTGA0511-P	-	TW20-100	Ø40~Ø160
6000 type	FTKA0615-P	-	TW25-100	Ø50~Ø250

➔ Maximum Angle Table for Ramping Machining

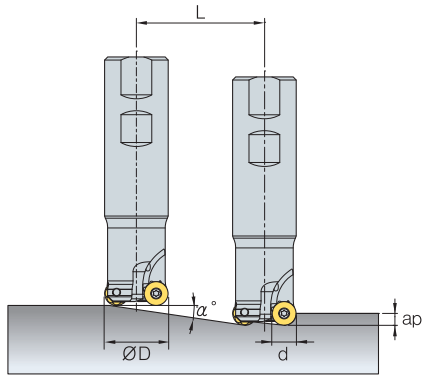

$$L \text{ min} = \frac{ap}{\tan \alpha^\circ} \text{ (mm)}$$

* L(mm) : Cutting length
 α° : Max. ramping angle
 ap(mm) : Depth of cut

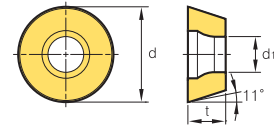

(mm)

Section	Insert size(d)	Tool Dia. (ØD)	Ramping angle α°(max)	Cutting length L(mm) by ap									
				ap=1	ap=2	ap=2.5	ap=3	ap=3.5	ap=4	ap=5	ap=6	ap=8	ap=10
FMR2500	8	17	4.7	12	24	30	36	42	48	-	-	-	-
	8	18	4.1	14	28	34	41	48	55	-	-	-	-
	8	20	15.4	4	7	9	11	13	14	-	-	-	-
	8	21	13.9	4	8	10	12	14	16	-	-	-	-
	8	25	9.8	6	12	14	17	20	23	-	-	-	-
	8	26	9.2	6	12	16	19	22	25	-	-	-	-
FMR3000	10	25	13.8	4	8	10	12	14	16	20	-	-	-
	10	26	12.6	4	9	11	13	16	18	22	-	-	-
	10	32	8.4	7	14	17	20	24	27	34	-	-	-
	10	33	8.0	7	14	18	21	25	29	36	-	-	-
	10	40	5.8	10	20	25	30	34	39	49	-	-	-
	10	50	4.2	14	27	34	41	48	55	68	-	-	-
	10	63	3.1	19	37	47	56	65	75	93	-	-	-
FMR4000	12	25	4.5	13	25	32	38	44	51	63	76	-	-
	12	26	4.1	14	28	35	42	49	56	70	84	-	-
	12	32	14.7	4	8	10	11	13	15	19	23	-	-
	12	33	13.8	4	8	10	12	14	16	20	24	-	-
	12	40	9.6	6	12	15	18	21	24	30	36	-	-
	12	50	6.7	9	17	21	26	30	34	43	51	-	-
	12	63	4.8	12	24	30	36	42	48	60	72	-	-
	12	66	4.5	13	26	32	38	45	51	64	77	-	-
	12	80	3.5	17	33	41	50	58	66	83	99	-	-
FMR5000	16	40	17.8	3	6	8	9	11	12	16	19	25	-
	16	50	11.3	5	10	13	15	18	20	25	30	40	-
	16	63	7.6	7	15	19	22	26	30	37	45	60	-
	16	66	7.1	8	16	20	24	28	32	40	48	64	-
	16	80	5.3	11	21	27	32	37	43	53	64	85	-
	16	100	4.0	14	29	36	43	51	58	72	87	116	-
	16	125	3.0	19	38	48	58	67	77	96	115	154	-
	16	160	2.2	26	52	65	78	90	103	129	155	207	-
FMR6000	20	50	17.8	3	6	8	9	11	12	16	19	25	31
	20	63	11.1	5	10	13	15	18	20	25	30	41	51
	20	80	7.4	8	15	19	23	27	31	38	46	61	77
	20	100	5.3	11	21	27	32	37	43	53	64	85	107
	20	125	4.0	14	29	36	43	51	58	72	87	116	145
	20	160	2.9	20	40	49	59	69	79	99	119	158	198
	20	200	2.2	26	52	65	78	90	103	129	155	207	258
	20	250	1.7	33	67	84	100	117	134	167	200	267	334

※ For insert size (d), see page 6, the applicable insert drawing

FMR P-positive

➔ Minimum Hole Diameter Table for Helical Machining (ØDHmin)

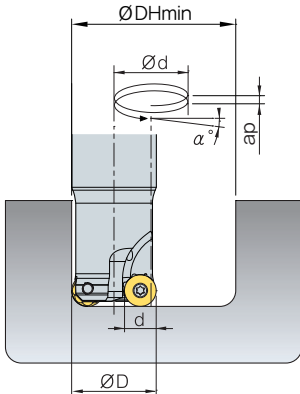

- ØD = Tool Dia. (mm)
- Ød (Tool Path, mm) = ØDHmin, max - ØD
- ØDHmin (Minimum hole diameter) = ØD × 2 - Insert size (d)
- ØDHmax (Maximum hole diameter) = ØD × 2 - 2
- Ramping angle by $ap(\alpha^\circ) = \tan^{-1} \left(\frac{ap}{\pi \times \text{Ød}} \right)$
Helical angle adjusted by ap cannot exceed maximum angle
- ap = Depth of cut

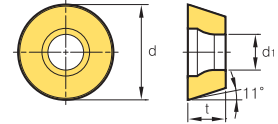

(mm)

Section	Insert size (d)	Tool Dia. (ØD)	Ramping angle $\alpha^\circ(\text{max})$	ØDH min	Ød	Cutting length L (mm) by ap									
						ap=1	ap=2	ap=2.5	ap=3	ap=3.5	ap=4	ap=5	ap=6	ap=8	ap=10
FMR 2500	8	17	4.7	26	9	2.03	4.06	-	-	-	-	-	-	-	-
	8	18	4.1	28	10	1.83	3.65	-	-	-	-	-	-	-	-
	8	20	15.4	32	12	1.52	3.04	3.81	4.57	5.34	6.11	-	-	-	-
	8	21	13.9	34	13	1.40	2.81	3.51	4.22	4.92	5.63	-	-	-	-
	8	25	9.8	42	17	1.07	2.15	2.69	3.22	3.76	4.30	-	-	-	-
	8	26	9.2	44	18	1.01	2.03	2.54	3.04	3.55	4.06	-	-	-	-
FMR 3000	10	25	13.8	40	15	1.22	2.43	3.04	3.65	4.27	4.88	-	-	-	-
	10	26	12.6	42	16	1.14	2.28	2.85	3.43	4.00	4.57	-	-	-	-
	10	32	8.4	54	22	0.83	1.66	2.07	2.49	2.91	3.32	-	-	-	-
	10	33	8.0	56	23	0.79	1.59	1.98	2.38	2.78	3.18	-	-	-	-
	10	40	5.8	70	30	0.61	1.22	1.52	1.83	2.13	2.43	-	-	-	-
	10	50	4.2	90	40	0.46	0.91	1.14	1.37	1.60	1.83	-	-	-	-
	10	63	3.1	116	53	0.34	0.69	0.86	1.03	1.21	1.38	-	-	-	-
	10	66	2.9	122	56	0.33	0.65	0.81	0.98	1.14	1.30	-	-	-	-
FMR 4000	12	25	4.5	38	13	1.40	2.81	3.51	-	-	-	-	-	-	-
	12	26	4.1	40	14	1.30	2.61	3.26	-	-	-	-	-	-	-
	12	32	14.7	52	20	0.91	1.83	2.28	2.74	3.20	3.65	4.57	5.49	-	-
	12	33	13.8	54	21	0.87	1.74	2.17	2.61	3.04	3.48	4.35	5.23	-	-
	12	40	9.6	68	28	0.65	1.30	1.63	1.96	2.28	2.61	3.26	3.92	-	-
	12	50	6.7	88	38	0.48	0.96	1.20	1.44	1.68	1.92	2.40	2.88	-	-
	12	63	4.8	114	51	0.36	0.72	0.89	1.07	1.25	1.43	1.79	2.15	-	-
	12	66	4.5	120	54	0.34	0.68	0.84	1.01	1.18	1.35	1.69	2.03	-	-
	12	80	3.5	148	68	0.27	0.54	0.67	0.81	0.94	1.07	1.34	1.61	-	-
	12	100	2.6	188	88	0.21	0.41	0.52	0.62	0.73	0.83	1.04	1.24	-	-
FMR 5000	16	40	17.8	64	24	0.76	1.52	1.90	2.28	2.66	3.04	3.81	4.57	6.11	-
	16	50	11.3	84	34	0.54	1.07	1.34	1.61	1.88	2.15	2.69	3.22	4.30	-
	16	63	7.6	110	47	0.39	0.78	0.97	1.16	1.36	1.55	1.94	2.33	3.11	-
	16	66	7.1	116	50	0.36	0.73	0.91	1.09	1.28	1.46	1.83	2.19	2.92	-
	16	80	5.3	144	64	0.29	0.57	0.71	0.86	1.00	1.14	1.43	1.71	2.28	-
	16	100	4.0	184	84	0.22	0.43	0.54	0.65	0.76	0.87	1.09	1.30	1.74	-
	16	125	3.0	234	109	0.17	0.33	0.42	0.50	0.59	0.67	0.84	1.00	1.34	-
	16	160	2.2	304	144	0.13	0.25	0.32	0.38	0.44	0.51	0.63	0.76	1.01	-
FMR 6000	20	50	17.8	80	30	0.61	1.22	1.52	1.83	2.13	2.43	3.04	3.65	4.88	6.11
	20	63	11.1	106	43	0.42	0.85	1.06	1.27	1.49	1.70	2.12	2.55	3.40	4.25
	20	80	7.4	140	60	0.30	0.61	0.76	0.91	1.06	1.22	1.52	1.83	2.43	3.04
	20	100	5.3	180	80	0.23	0.46	0.57	0.68	0.80	0.91	1.14	1.37	1.83	2.28
	20	125	4.0	230	105	0.17	0.35	0.43	0.52	0.61	0.70	0.87	1.04	1.39	1.74
	20	160	2.9	300	140	0.13	0.26	0.33	0.39	0.46	0.52	0.65	0.78	1.04	1.30
	20	200	2.2	380	180	0.10	0.20	0.25	0.30	0.35	0.41	0.51	0.61	0.81	1.01
	20	250	1.7	480	230	0.08	0.16	0.20	0.24	0.28	0.32	0.40	0.48	0.63	0.79

※ For insert size (d), see page 6, the applicable insert drawing

➔ Maximum Hole Diameter Table for Helical Machining (ØDHmax)

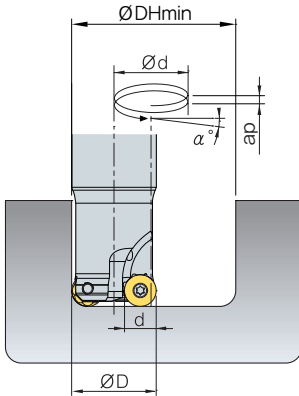

- ØD = Tool Dia. (mm)
- Ød (Tool Path, mm) = ØDHmin, max - ØD
- ØDHmin (Minimum hole diameter) = ØD × 2 - Insert size (d)
- ØDHmax (Maximum hole diameter) = ØD × 2 - 2
- Ramping angle by $ap(\alpha^\circ) = \tan^{-1} \left(\frac{ap}{\pi \times \text{Ød}} \right)$
Helical angle adjusted by ap cannot exceed maximum angle
- ap = Depth of cut

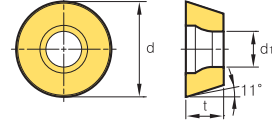

(mm)

Section	Insert size (d)	Tool Dia. (ØD)	Ramping angle $\alpha^\circ(\text{max})$	ØDH max	Ød	Cutting length L (mm) by ap									
						ap=1	ap=2	ap=2.5	ap=3	ap=3.5	ap=4	ap=5	ap=6	ap=8	ap=10
FMR 2500	8	17	4.7	32	15	1.22	2.43	3.04	3.65	-	-	-	-	-	-
	8	18	4.1	34	16	1.14	2.28	2.85	3.43	-	-	-	-	-	-
	8	20	15.4	38	18	1.01	2.03	2.54	3.04	3.55	4.06	-	-	-	-
	8	21	13.9	40	19	0.96	1.92	2.40	2.88	3.37	3.85	-	-	-	-
	8	25	9.8	48	23	0.79	1.59	1.98	2.38	2.78	3.18	-	-	-	-
	8	26	9.2	50	24	0.76	1.52	1.90	2.28	2.66	3.04	-	-	-	-
FMR 3000	10	25	13.8	48	23	0.79	1.59	1.98	2.38	2.78	3.18	-	-	-	-
	10	26	12.6	50	24	0.76	1.52	1.90	2.28	2.66	3.04	-	-	-	-
	10	32	8.4	62	30	0.61	1.22	1.52	1.83	2.13	2.43	-	-	-	-
	10	33	8.0	64	31	0.59	1.18	1.47	1.77	2.06	2.36	-	-	-	-
	10	40	5.8	78	38	0.48	0.96	1.20	1.44	1.68	1.92	-	-	-	-
	10	50	4.2	98	48	0.38	0.76	0.95	1.14	1.33	1.52	-	-	-	-
	10	63	3.1	124	61	0.30	0.60	0.75	0.90	1.05	1.20	-	-	-	-
	10	66	2.9	130	64	0.29	0.57	0.71	0.86	1.00	1.14	-	-	-	-
FMR 4000	12	25	4.5	48	23	0.79	1.59	1.98	2.38	2.78	3.18	-	-	-	-
	12	26	4.1	50	24	0.76	1.52	1.90	2.28	2.66	3.04	-	-	-	-
	12	32	14.7	62	30	0.61	1.22	1.52	1.83	2.13	2.43	3.04	3.65	-	-
	12	33	13.8	64	31	0.59	1.18	1.47	1.77	2.06	2.36	2.95	3.54	-	-
	12	40	9.6	78	38	0.48	0.96	1.20	1.44	1.68	1.92	2.40	2.88	-	-
	12	50	6.7	98	48	0.38	0.76	0.95	1.14	1.33	1.52	1.90	2.28	-	-
	12	63	4.8	124	61	0.30	0.60	0.75	0.90	1.05	1.20	1.50	1.80	-	-
	12	66	4.5	130	64	0.29	0.57	0.71	0.86	1.00	1.14	1.43	1.71	-	-
	12	80	3.5	158	78	0.23	0.47	0.58	0.70	0.82	0.94	1.17	1.40	-	-
	12	100	2.6	198	98	0.19	0.37	0.47	0.56	0.65	0.74	0.93	1.12	-	-
FMR 5000	16	40	17.8	78	38	0.48	0.96	1.20	1.44	1.68	1.92	2.40	2.88	3.85	-
	16	50	11.3	98	48	0.38	0.76	0.95	1.14	1.33	1.52	1.90	2.28	3.04	-
	16	63	7.6	124	61	0.30	0.60	0.75	0.90	1.05	1.20	1.50	1.80	2.39	-
	16	66	7.1	130	64	0.29	0.57	0.71	0.86	1.00	1.14	1.43	1.71	2.28	-
	16	80	5.3	158	78	0.23	0.47	0.58	0.70	0.82	0.94	1.17	1.40	1.87	-
	16	100	4.0	198	98	0.19	0.37	0.47	0.56	0.65	0.74	0.93	1.12	1.49	-
	16	125	3.0	248	123	0.15	0.30	0.37	0.45	0.52	0.59	0.74	0.89	1.19	-
	16	160	2.2	318	158	0.12	0.23	0.29	0.35	0.40	0.46	0.58	0.69	0.92	-
FMR 6000	20	50	17.8	98	48	0.38	0.76	0.95	1.14	1.33	1.52	1.90	2.28	3.04	3.81
	20	63	11.1	124	61	0.30	0.60	0.75	0.90	1.05	1.20	1.50	1.80	2.39	2.99
	20	80	7.4	158	78	0.23	0.47	0.58	0.70	0.82	0.94	1.17	1.40	1.87	2.34
	20	100	5.3	198	98	0.19	0.37	0.47	0.56	0.65	0.74	0.93	1.12	1.49	1.86
	20	125	4.0	248	123	0.15	0.30	0.37	0.45	0.52	0.59	0.74	0.89	1.19	1.48
	20	160	2.9	318	158	0.12	0.23	0.29	0.35	0.40	0.46	0.58	0.69	0.92	1.16
	20	200	2.2	398	198	0.09	0.18	0.23	0.28	0.32	0.37	0.46	0.55	0.74	0.92
	20	250	1.7	498	248	0.07	0.15	0.18	0.22	0.26	0.29	0.37	0.44	0.59	0.74

※ For insert size (d), see page 6, the applicable insert drawing

FMR P-positive

FMRS2500(Shank)



• AR : -4°
• RR : -4°~1°

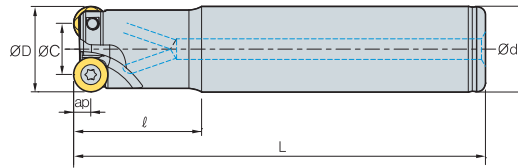

(mm)

	Designation		ØD	ØC	Ød	l	L	ap		Insert size
FMRS	2517HRP-2S16	2	17	9	16	35	90	4	0.11	8
	2517HRP-2M16	2	17	9	16	35	150	4	0.20	8
	2517HRP-2L16	2	17	9	16	35	200	4	0.27	8
	2518HRP-2M16	2	18	10	16	35	150	4	0.20	8
	2518HRP-2L16	2	18	10	16	35	200	4	0.28	8
	2520HRP-3S20	3	20	12	20	35	130	4	0.27	8
	2520HRP-3M20	3	20	12	20	100	180	4	0.36	8
	2520HRP-3L20	3	20	12	20	130	250	4	0.50	8
	2521HRP-3S20	3	21	13	20	35	130	4	0.28	8
	2521HRP-3M20	3	21	13	20	35	180	4	0.40	8
	2521HRP-3L20	3	21	13	20	35	250	4	0.55	8
	2525HRP-4S25	4	25	17	25	35	150	4	0.48	8
	2525HRP-4M25	4	25	17	25	60	180	4	0.60	8
	2525HRP-4L25	4	25	17	25	130	250	4	0.81	8
2526HRP-4S25	4	26	18	25	35	150	4	0.48	8	
2526HRP-4L25	4	26	18	25	130	250	4	0.85	8	

Available Inserts



RPET-ML



RPMT-MF



RPMT-MM



RPMW

Designation	Usage	Coated					Uncoated
		PC2505	PC2510	PC3600	PC5300	PC5400	H01
RPET 0803M0E-ML	Titanium & Inconel machining				●	●	
RPMT 0803M0E-MF	Low cutting resistance machining			●	●	●	
0803M0S-MM	Stronger cutting edge			●	●	●	
RPMW 0803M0E1	High hardness material machining			●	●	●	

● : Stock item

Parts

Specification	Screw 	Wrench 	Wrench 	Holder Dia.
Ø17 ~ Ø26	FTNA0305 FTNA0306	TW09S	-	Ø17 Ø18~Ø26

- For recommended cutting conditions for workpiece and grade, see the bottom of page 4
- For insert size (d), see page 6, the applicable insert drawing

FMRS3000(Shank)



• AR : -4°
• RR : -1°

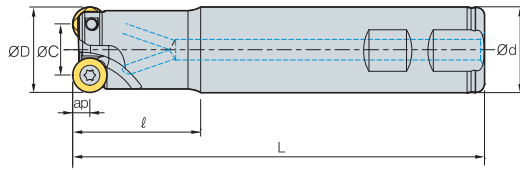

Fig. 1

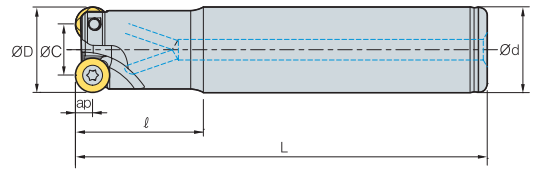

Fig. 2

(mm)

	Designation		ØD	ØC	Ød	l	L	ap		Fig.	Insert size
FMRS	3025HRP-2M20	2	25	15	20	40	170	5	0.40	2	10
	3025HRP-2S25	2	25	15	25	40	120	5	0.39	1	10
	3025HRP-2M25	2	25	15	25	60	160	5	0.52	2	10
	3025HRP-2L25	2	25	15	25	130	250	5	0.80	2	10
	3026HRP-2L25	2	26	16	25	30	200	5	0.69	2	10
	3032HRP-3S32	3	32	22	32	40	125	5	0.68	1	10
	3032HRP-3L32	3	32	22	32	60	200	5	1.08	2	10
	3032HRP-4S32	4	32	22	32	40	125	5	0.66	1	10
	3032HRP-4L25	4	32	22	25	60	200	5	0.74	2	10
	3033HRP-4S32	4	33	23	32	40	125	5	0.67	1	10
	3033HRP-4M32	4	33	23	32	60	180	5	1.00	2	10
	3033HRP-4L32	4	33	23	32	180	300	5	1.64	2	10

Available Inserts



RPCT-MA



RPET-ML



RPMT-MF



RPMT-MM



RPMW

Designation	Usage	Coated					Uncoated
		PC2505	PC2510	PC3600	PC5300	PC5400	H01
RPCT 10T3M0-MA	Al machining						●
RPET 10T3M0E-ML	Titanium & Inconel machining				●	●	
RPMT 10T3M0E-MF	Low cutting resistance machining			●	●	●	
10T3M0S-MM	Stronger cutting edge			●	●	●	
RPMW 10T3M0E1	High hardness material machining			●	●	●	

● : Stock item

Parts

Specification	Screw	Wrench	Wrench	Holder Dia.
Ø25~Ø33	 FTGA03507 FTGA03508	 TW15S	 -	 Ø25~Ø26 Ø32~Ø33

- For recommended cutting conditions for workpiece and grade, see the bottom of page 4
- For insert size (d), see page 6, the applicable insert drawing

FMR P-positive

FMRS4000(Shank)



• AR : -4°
• RR : -2°-0°

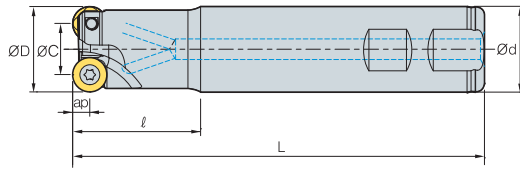

Fig. 1

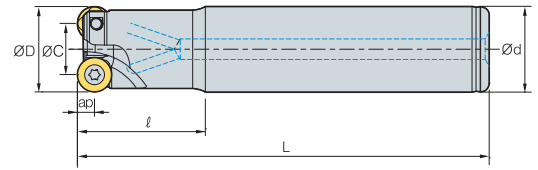

Fig. 2

(mm)

	Designation		ØD	ØC	Ød	ℓ	L	ap		Fig.	Insert size
FMRS	4025HRP-2S25	2	25	13	25	60	160	6	0.46	1	12
	4026HRP-2L25	2	26	14	25	60	200	6	0.48	2	12
	4032HRP-2L25	2	32	20	25	40	190	6	0.68	2	12
	4032HRP-2S32	2	32	20	32	50	125	6	0.64	1	12
	4032HRP-2L32	2	32	20	32	50	250	6	1.40	2	12
	4032HRP-3S32	3	32	20	32	50	125	6	0.64	1	12
	4032HRP-3M32	3	32	20	32	60	160	6	0.85	2	12
	4033HRP-3M32	3	33	21	32	60	200	6	1.01	2	12
	4033HRP-3L32	3	33	21	32	60	300	6	1.67	2	12
	4040HRP-3S32	3	40	28	32	35	105	6	0.60	1	12
	4040HRP-3M32	3	40	28	32	50	160	6	0.96	2	12
	4040HRP-4S32	4	40	28	32	35	105	6	0.60	1	12
	4040HRP-4M32	4	40	28	32	35	150	6	0.87	2	12
	4040HRP-4L32	4	40	28	32	35	250	6	1.46	2	12
	4050HRP-4M32	4	50	38	32	50	150	6	1.10	2	12
4050HRP-4M40	4	50	38	40	50	150	6	1.44	2	12	
4050HRP-4M42	4	50	38	42	50	150	6	1.55	2	12	

Available Inserts



RPCT-MA



RPET-ML



RPMT-MF



RPMT-MM



RPMW

Designation	Usage	Coated					Uncoated
		PC2505	PC2510	PC3600	PC5300	PC5400	H01
RPCT 1204M0-MA	Al machining						●
RPET 1204M0E-ML	Titanium & Inconel machining				●	●	
RPMT 1204M0E-MF	Low cutting resistance machining			●	●	●	
1204M0S-MM	Stronger cutting edge			●	●	●	
RPMW 1204M0S1	High hardness material machining			●	●	●	
1204M0S2	High hardness material machining(with Stronger cutting edge)				●	●	

● : Stock item

Parts

Specification	Screw 	Wrench 	Wrench 	Holder Dia.
Ø25~Ø50	FTKA0408 FTKA0410	TW15S	-	Ø25~Ø26 Ø32~Ø50

- For recommended cutting conditions for workpiece and grade, see the bottom of page 4
- For insert size (d), see page 6, the applicable insert drawing

FMRS5000 / 6000(Shank)



• AR : -4°
• RR : -2°~0°

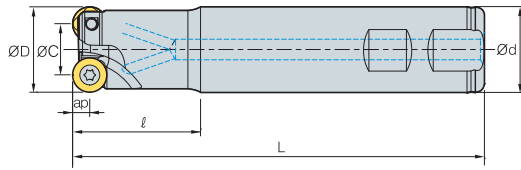

Fig. 1

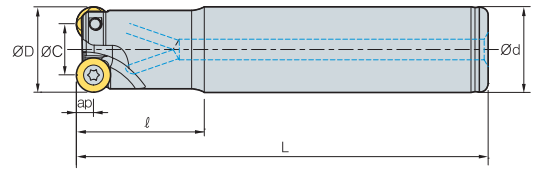

Fig. 2

(mm)

	Designation		ØD	ØC	Ød	ℓ	L	ap		Fig.	Insert size
FMRS	5040HRP-2M32	2	40	24	32	50	160	8	0.92	2	16
	5040HRP-2L32	2	40	24	32	50	250	8	1.45	2	16
	5050HRP-3M40	3	50	34	40	50	160	8	1.48	2	16
	5050HRP-3L40	3	50	34	40	50	300	8	2.86	2	16
FMRS	6050HRP-3S32	3	50	30	32	50	160	10	1.06	1	20
	6050HRP-3M32	3	50	30	32	50	200	10	1.30	2	20
	6050HRP-3S40	3	50	30	40	50	125	10	1.45	1	20
	6050HRP-3M40	3	50	30	40	50	200	10	1.85	2	20

Available Inserts



RPCT-MA



RPET-ML



RPMT-MF



RPMT-MM



RPMW

Type	Designation	Usage	Coated					Uncoated
			PC2505	PC2510	PC3600	PC5300	PC5400	H01
5000 type	RPCT 1606M0-MA	Al machining						●
	RPET 1606M0E-ML	Titanium & Inconel machining				●	●	
	RPMT 1606M0E-MF	low cutting resistance machining			●	●	●	
	1606M0S-MM	Stronger cutting edge			●	●	●	
RPMW 1606M0S1	High hardness material machining			●	●	●		
6000 type	RPCT 2007M0-MA	Al machining						●
	RPET 2007M0-ML	Titanium & Inconel machining				●	●	
	RPMT 2007M0E-MF	Low cutting resistance machining			●	●	●	
	2007M0S-MM	Stronger cutting edge			●	●	●	
	RPMW 2007M0S1	High hardness material machining			●	●	●	

● : Stock item

Parts

Specification	Screw 	Wrench 	Wrench 	Holder Dia.
Ø40 ~ Ø50 (5000 type)	FTGA0511-P	-	TW20-100	Ø40~Ø50
Ø50 (6000 type)	FTKA0615-P	-	TW25-100	Ø50

- For recommended cutting conditions for workpiece and grade, see the bottom of page 4
- For insert size (d), see page 6, the applicable insert drawing

FMR P-positive

FMRCM3000(Cutter)

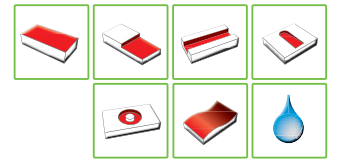
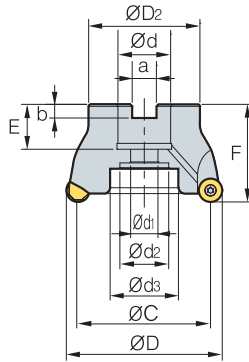

· AR : -5°
· RR : -4°-0°

(mm)

Designation	⊙	ØD	ØC	ØD ₂	Ød	Ød ₁	Ød ₂	Ød ₃	a	b	E	F	ap	kg	Insert size	
FMRCM	3040HRP-5	5	40	30	38	16	9	14	-	8.4	5.6	19	40	5	0.22	10
	3050HRP-6	6	50	40	45	22	11	18	-	10.4	6.3	20	40	5	0.35	10
	3052HRP-6	6	52	42	45	22	11	18	-	10.4	6.3	20	40	5	0.37	10
	3063HRP-6	6	63	53	50	22	11	18	-	10.4	6.3	20	40	5	0.55	10
	3063HRP-7	7	63	53	50	22	11	18	-	10.4	6.3	20	40	5	0.56	10
	3066HRP-7	7	66	56	50	22	11	18	-	10.4	6.3	20	40	5	0.60	10

Available Inserts



RPCT-MA



RPET-ML



RPMT-MF



RPMT-MM



RPMW

Designation	Usage	Coated					Uncoated
		PC2505	PC2510	PC3600	PC5300	PC5400	H01
RPCT 10T3M0-MA	Al machining						●
RPET 10T3M0E-ML	Titanium & Inconel machining				●	●	
RPMT 10T3M0E-MF	Low cutting resistance machining			●	●	●	
10T3M0S-MM	Stronger cutting edge			●	●	●	
RPMW 10T3M0E1	High hardness material machining			●	●	●	

● : Stock item

Available Arbors

Designation	Ød	Available Arbors
FMRCM 3040HRP-5	16	BT□□-FMC16-□□
3050HRP-6	22	BT□□-FMC22-□□
3052HRP-6	22	BT□□-FMC22-□□
3063HRP-6	22	BT□□-FMC22-□□
3063HRP-7	22	BT□□-FMC22-□□
3066HRP-7	22	BT□□-FMC22-□□

Parts

Specification	Screw	Wrench	Wrench	Holder Dia.
Ø40~Ø66	FTGA03508	TW15S	-	Ø40~Ø66

- For recommended cutting conditions for workpiece and grade, see the bottom of page 4
- For insert size (d), see page 6, the applicable insert drawing

FMRC(M)4000(Cutter)

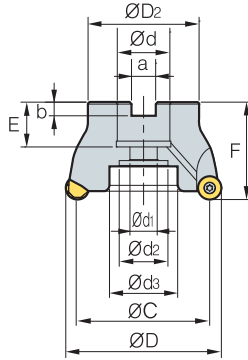

• AR : -5°
• RR : -2°-0°

(mm)

Designation			ØD	ØC	ØD ₂	Ød	Ød ₁	Ød ₂	Ød ₃	a	b	E	F	ap		Insert size
FMRCM	4050HRP-4	4	50	38	45	22	11	18	-	10.4	6.3	20	40	6	0.26	12
	4050HRP-5	5	50	38	45	22	11	18	-	10.4	6.3	20	40	6	0.28	12
	4052HRP-5	5	52	40	45	22	11	18	-	10.4	6.3	20	40	6	0.30	12
	4063HRP-5	5	63	51	50	22	11	18	-	10.4	6.3	20	40	6	0.44	12
	4063HRP-6	6	63	51	50	22	11	18	-	10.4	6.3	20	40	6	0.48	12
	4066HRP-6	6	66	54	50	22	11	18	-	10.4	6.3	20	40	6	0.50	12
FMRC (FMRCM)	4080HRP-6	6	80	68	57	25.4(27)	14	25	35	9.5(12.4)	6(7)	24(23)	50	6	0.92	12
	4080HRP-7	7	80	68	57	25.4(27)	14	25	35	9.5(12.4)	6(7)	24(23)	50	6	0.90	12
	4100HRP-7	7	100	88	67	31.75(32)	18	26	42	12.7(14.4)	8(8)	32(25)	63(53)	6	1.46	12

() Metric Size

Available Inserts



RPCT-MA



RPET-ML



RPMT-MF



RPMT-MM



RPMW

Designation	Usage	Coated					Uncoated
		PC2505	PC2510	PC3600	PC5300	PC5400	H01
RPCT 1204M0-MA	Al machining						●
RPET 1204M0E-ML	Titanium & Inconel machining				●	●	
RPMT 1204M0E-MF 1204M0S-MM	Low cutting resistance machining			●	●	●	
	Stronger cutting edge			●	●	●	
RPMW 1204M0S1 1204M0S2	High hardness material machining			●	●	●	
	High hardness material machining(with Stronger cutting edge)				●	●	

● : Stock item

Available Arbors

Designation	Ød	Available Arbors		
FMRCM 4050HRP-4 4050HRP-5 4052HRP-5 4063HRP-5 4063HRP-6 4066HRP-6	22	BT□□-FMC22-□□		
		FMRC(M) 4080HRP-6	BT□□-FMA25.4-□□	
			BT□□-FMC27-□□	
			BT□□-FMA25.4-□□	
		4080HRP-7	25.4	BT□□-FMC27-□□
			27	BT□□-FMA31.75-□□
4100HRP-7	31.75	BT□□-FMC32-□□		
	32			

Parts

Specification	Screw 	Wrench 	Wrench 	Holder Dia.
Ø50 ~ Ø100	FTKA0410	TW15S	-	Ø50~Ø100

- For recommended cutting conditions for workpiece and grade, see the bottom of page 4
- For insert size (d), see page 6, the applicable insert drawing

FMR P-positive

FMRC(M)5000(Cutter)

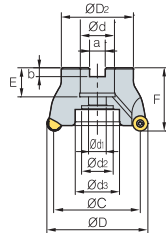

Fig. 1

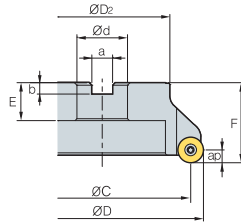

Fig. 2

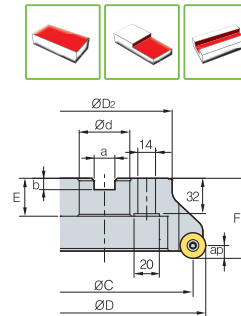

Fig. 3

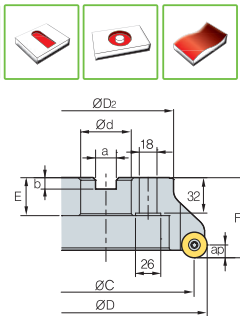

Fig. 4

• AR : -5°
• RR : -1°~0°

(mm)

형번	공정	ØD	ØC	ØD ₂	Ød	Ød ₁	Ød ₂	Ød ₃	a	b	E	F	ap	궤차	그림	인서트치수	
FMRCM	5063HRP-4	4	63	47	50	22	11	18	-	10.4	6.3	20	40	8	0.43	1	16
	5063HRP-5	5	63	47	50	22	11	18	-	10.4	6.3	20	40	8	0.44	1	16
	5066HRP-5	5	66	50	50	22	11	18	-	10.4	6.3	20	40	8	0.48	1	16
FMRC (FMRCM)	5080HRP-5	5	80	64	57	25.4(27)	14	25	35	9.5(12.4)	6(7)	24(23)	50	8	0.77	1	16
	5080HRP-6	6	80	64	57	25.4(27)	14	25	35	9.5(12.4)	6(7)	24(23)	50	8	0.82	1	16
	5100HRP-6	6	100	84	67	31.75(32)	18	26	42	12.7(14.4)	8(8)	32(25)	63(55)	8	1.42	1	16
	5125HRP-7	7	125	109	87	38.1(40)	22	32	52	15.9(16.4)	10(9)	35(29)	68(63)	8	2.78	1	16
	5125HRP-8	8	125	109	87	38.1(40)	22	32	52	15.9(16.4)	10(9)	35(29)	68(63)	8	2.79	1	16
5160RP-8	8	160	144	107	50.8(40)	-	-	100	19(16.4)	11(9)	38(32)	63	8	4.01	2(3)	16	

() Metric Size

Available Inserts



RPCT-MA



RPET-ML



RPMT-MF



RPMT-MM



RPMW

Designation	Usage	Coated					Uncoated
		PC2505	PC2510	PC3600	PC5300	PC5400	H01
RPCT 1606MO-MA	Al machining						●
RPET 1606MOE-ML	Titanium & Inconel machining				●	●	
RPMT 1606MOE-MF	Low cutting resistance machining			●	●	●	
1606MOS-MM	Stronger cutting edge			●	●	●	
RPMW 1606MOS1	High hardness material machining			●	●	●	

● : Stock item

Available Arbors

Designation	Ød	Available Arbors
FMRCM	22	5063HRP-4
		5063HRP-5
		5066HRP-5
FMRC(M)	25.4	5080HRP-5
		5080HRP-6
	27	5080HRP-5
		5080HRP-6

Designation	Ød	Available Arbors
FMRC(M)	5100HRP-6	BT□□-FMA31.75-□□ BT□□-FMC32-□□
	5125HRP-7	BT□□-FMA38.1-□□ BT□□-FMC40-□□
5125HRP-8	38.1	BT□□-FMA38.1-□□
	40	BT□□-FMC40-□□
5160RP-8	50.8	BT□□-FMA50.8-□□
	40	BT□□-FMC40-□□

Parts

Specification	Screw	Wrench	Wrench	Holder Dia.
Ø63~Ø160	FTGA0512-P	-	TW20-100	Ø63~Ø160

- For recommended cutting conditions for workpiece and grade, see the bottom of page 4
- For insert size (d), see page 6, the applicable insert drawing

FMRC(M)6000(Cutter)

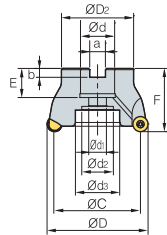

Fig. 1

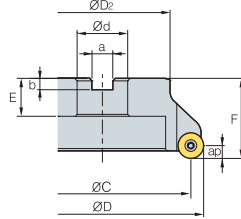

Fig. 2



• AR : -5°
• RR : -1°~0°

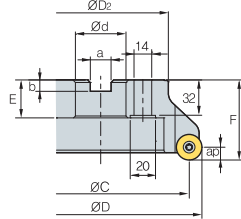

Fig. 3

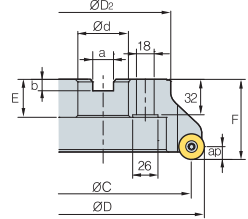

Fig. 4

(mm)

형번	치수	ØD	ØC	ØD ₂	Ød	Ød ₁	Ød ₂	Ød ₃	a	b	E	F	ap	궤차	그림	인서트치수	
FMRCM	6063HRP-4	4	63	43	50	22	11	18	-	10.4	6.3	20	40	10	0.37	1	20
FMRC (FMRCM)	6080HRP-5	5	80	60	57	25.4(27)	14	25	35	9.5(12.4)	6(7)	24(23)	50	10	0.87	1	20
	6100HRP-5	5	100	80	67	31.75(32)	18	26	42	12.7(14.4)	8(8)	32(25)	63(55)	10	1.31	1	20
	6100HRP-6	6	100	80	67	31.75(32)	18	26	42	12.7(14.4)	8(8)	32(25)	63(55)	10	1.40	1	20
	6125HRP-5	5	125	105	87	38.1(40)	22	32	52	15.9(16.4)	10(9)	35(29)	68(63)	10	2.77	1	20
	6125HRP-7	7	125	105	87	38.1(40)	22	32	52	15.9(16.4)	10(9)	35(29)	68(63)	10	2.89	1	20
	6160RP-6	6	160	140	107	50.8(40)	-	-	100	19(16.4)	11(9)	38(32)	63	10	3.58	2(3)	20
	6160RP-8	8	160	140	107	50.8(40)	-	-	100	19(16.4)	11(9)	38(32)	63	10	3.53	2(3)	20
	6200RP-8	8	200	180	130	47.625(60)	-	-	132	25.4(25.7)	14(14)	38	63	10	5.15	4	20
	6250RP-9	9	250	230	180	47.625(60)	-	-	180	25.4(25.7)	14(14)	38	63	10	9.72	4	20

() Metric Size

Available Inserts



RPCT-MA



RPET-ML



RPMT-MF



RPMT-MM



RPMW

Designation	Usage	Coated				Uncoated	
		PC2505	PC2510	PC3600	PC5300	PC5400	H01
RPCT 2007M0-MA	Al machining						●
RPET 2007M0E-ML	Titanium & Inconel machining				●	●	
RPMT 2007M0E-MF	Low cutting resistance machining			●	●	●	
2007M0S-MM	Stronger cutting edge			●	●	●	
RPMW 2007M0S1	High hardness material machining			●	●	●	

● : Stock item

Available Arbors

Designation	Ød	Available Arbors
FMRCM 6063HRP-4	22	BT□□-FMC22-□□
FMRC(M) 6080HRP-5	25.4	BT□□-FMA25.4-□□
	27	BT□□-FMC27-□□
6100HRP-5	31.75	BT□□-FMA31.75-□□
	32	BT□□-FMC32-□□
6100HRP-6	31.75	BT□□-FMA31.75-□□
	32	BT□□-FMC32-□□
6125HRP-5	38.1	BT□□-FMA38.1-□□
	40	BT□□-FMC40-□□

Designation	Ød	Available Arbors
FMRC(M) 6125HRP-7	38.1	BT□□-FMA38.1-□□
	40	BT□□-FMC40-□□
6160RP-6	50.8	BT□□-FMA50.8-□□
	40	BT□□-FMC40-□□
6160RP-8	50.8	BT□□-FMA50.8-□□
	40	BT□□-FMC40-□□
6200RP-8	47.625	BT□□-FMA47.625-□□
	60	BT□□-FMC60-□□
6250RP-9	47.625	BT□□-FMA47.625-□□
	60	BT□□-FMC60-□□

Parts

Specification	Screw	Wrench	Wrench	Holder Dia.
Ø63~Ø250	FTKA0615-P	-	TW25-100	Ø63~Ø250

- For recommended cutting conditions for workpiece and grade, see the bottom of page 4
- For insert size (d), see page 6, the applicable insert drawing

FMR P-positive

⇒ FMRM2500 / 3000(Modular)



• AR : -4°
• RR : -4°-0°

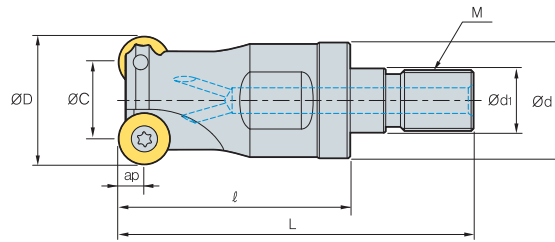

(mm)

Designation			ØD	ØC	Ød	Ød ₁	ℓ	L	M	ap		Insert size
FMRM	2517HRP-M08	2	17	9	14.5	8.5	25	42	M08	4	0.03	8
	2521HRP-M10	3	21	13	18	10.5	30	51	M10	4	0.06	8
	2526HRP-M12	4	26	18	23	12.5	35	59	M12	4	0.11	8
	2533HRP-M16	4	33	25	29	17	40	67	M16	4	0.22	8
	2540HRP-M16	5	40	32	29	17	40	67	M16	4	0.26	8
FMRM	3026HRP-M12	2	26	16	23	12.5	35	59	M12	5	0.10	10
	3033HRP-M16	3	33	23	29	17	40	67	M16	5	0.20	10
	3035HRP-M16	3	35	25	29	17	40	67	M16	5	0.22	10
	3040HRP-M16	3	40	30	29	17	40	67	M16	5	0.25	10
	3042HRP-M16	3	42	32	29	17	40	67	M16	5	0.27	10

▶ Available Inserts



RPCT-MA



RPET-ML



RPMT-MF



RPMT-MM



RPMW

Type	Designation	Usage	Coated					Uncoated
			PC2505	PC2510	PC3600	PC5300	PC5400	H01
2500 type	RPET 0803M0E-ML	Titanium & Inconel machining				●	●	
	RPMT 0803M0E-MF	Low cutting resistance machining			●	●	●	
	0803M0S-MM	Stronger cutting edge			●	●	●	
	RPMW 0803M0E1	High hardness material machining			●	●	●	
3000 type	RPCT 10T3M0-MA	Al machining						●
	RPET 10T3M0E-ML	Titanium & Inconel machining				●	●	
	RPMT 10T3M0E-MF	Low cutting resistance machining			●	●	●	
	10T3M0S-MM	Stronger cutting edge			●	●	●	
	RPMW 10T3M0E1	High hardness material machining			●	●	●	

● : Stock item

▶ Parts

Specification	Screw 	Wrench 	Wrench 	Holder Dia.
Ø17~Ø40 (2500 type)	FTNA0305	TW09S	-	Ø17
	FTNA0306			Ø21~Ø40
Ø26~Ø42 (3000 type)	FTGA03507	TW15S	-	Ø26
	FTGA03508			Ø33~Ø42

- For recommended cutting conditions for workpiece and grade, see the bottom of page 4
- For insert size (d), see page 6, the applicable insert drawing

FMRM4000 / 5000(Modular)



• AR : -4°
• RR : 0°

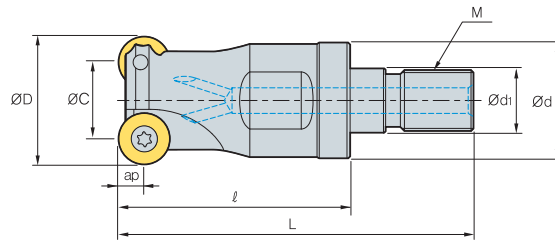

(mm)

	Designation		ØD	ØC	Ød	Ød ₁	ℓ	L	M	ap		Insert size
FMRM	4026HRP-M12	2	26	14	23	12.5	35	59	M12	6	0.10	12
	4033HRP-M16	3	33	21	29	17	40	67	M16	6	0.21	12
	4035HRP-M16	3	35	23	29	17	40	67	M16	6	0.21	12
	4040HRP-M16	4	40	28	29	17	40	67	M16	6	0.24	12
	4042HRP-M16	4	42	30	29	17	40	67	M16	6	0.25	12
FMRM	5040HRP-M16	2	40	24	29	17	40	67	M16	8	0.21	16
	5042HRP-M16	2	42	26	29	17	40	67	M16	8	0.23	16

Available Inserts



RPCT-MA



RPET-ML



RPMT-MF



RPMT-MM



RPMW

Type	Designation	Usage	Coated					Uncoated	
			PC2505	PC2510	PC3600	PC5300	PC5400	H01	
4000 type	RPCT 1204M0-MA	Al machining							●
	RPET 1204M0-ML	Titanium & Inconel machining				●	●		
	RPMT 1204M0E-MF	Low cutting resistance machining			●	●	●		
	RPMT 1204M0S-MM	Stronger cutting edge			●	●	●		
	RPMW 1204M0S1	High hardness material machining			●	●	●		
	1204M0S2	High hardness material machining (With stronger cutting edge)				●	●		
5000 type	RPCT 1606M0-MA	Al machining							●
	RPET 1606M0E-ML	Titanium & Inconel machining				●	●		
	RPMT 1606M0E-MF	Low cutting resistance machining			●	●	●		
	RPMT 1606M0S-MM	Stronger cutting edge			●	●	●		
	RPMW 1606M0S1	High hardness material machining			●	●	●		

● : Stock item

Parts

Specification	Screw 	Wrench 	Wrench 	Holder Dia.
Ø26~Ø42 (4000 type)	FTKA0408	TW15S	-	Ø26
	FTKA0410			Ø33~Ø42
Ø40~Ø42 (5000 type)	FTGA0511-P	-	TW20-100	Ø40~Ø42

- For recommended cutting conditions for workpiece and grade, see the bottom of page 4
- For insert size (d), see page 6, the applicable insert drawing

FMR P-positive

⇒ MAT (Steel Shank type)

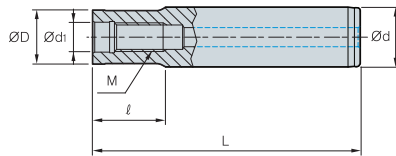

Fig. 1

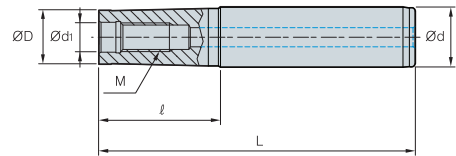

Fig. 2

(mm)

Designation		ØD	Ød	Ød ₁	ℓ	L	M	Fig
MAT	M06-020-S10S	9.5	10	6.5	20	70	M06	1
	M6B-020-S12S	11.0	12	6.5	20	76	M06	1
	M6B-040-S12S	11.0	12	6.5	40	96	M06	1
	M08-020-S16S	14.5	16	8.5	20	80	M08	1
	M10-030-S20S	18.0	20	10.5	30	100	M10	1
	M12-030-S25S	22.5	25	12.5	29	110	M12	1
	M16-035-S32S	28.5	32	17.0	35	125	M16	1
	M06-040-S12T	9.5	12	6.5	40	96	M06	2
	M06-065-S16T	9.5	16	6.5	65	125	M06	2
	M6B-065-S16T	11.0	16	6.5	65	125	M06	2
	M6B-080-S16T	11.0	16	6.5	80	140	M06	2
	M08-040-S16T	14.5	16	8.5	40	100	M08	2
	M08-065-S16T	14.5	16	8.5	65	125	M08	2
	M08-080-S20T	14.5	20	8.5	80	150	M08	2
	M08-110-S25T	14.5	25	8.5	110	190	M08	2
	M10-050-S20T	18.0	20	10.5	50	120	M10	2
	M10-070-S20T	18.0	20	10.5	70	140	M10	2
	M10-090-S25T	18.0	25	10.5	90	170	M10	2
	M10-110-S25T	18.0	25	10.5	110	190	M10	2
	M10-130-S32T	18.0	32	10.5	130	220	M10	2
	M12-050-S25T	22.5	25	12.5	50	130	M12	2
	M12-070-S25T	22.5	25	12.5	70	150	M12	2
	M12-090-S25T	22.5	25	12.5	90	170	M12	2
	M12-110-S32T	22.5	32	12.5	110	200	M12	2
	M12-175-S40T	22.5	40	12.5	175	300	M12	2
	M16-055-S32T	28.5	32	17.0	55	145	M16	2
	M16-080-S32T	28.5	32	17.0	80	170	M16	2
	M16-120-S32T	28.5	32	17.0	120	210	M16	2
M16-175-S40T	28.5	40	17.0	175	300	M16	2	

- S : Straight Neck Adapter
- T : Taper Neck Adapter

⇒ MAT-C (Carbide Shank type)

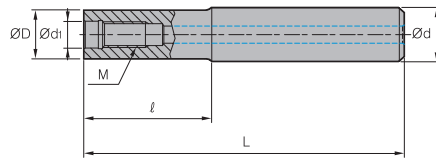

Fig. 1

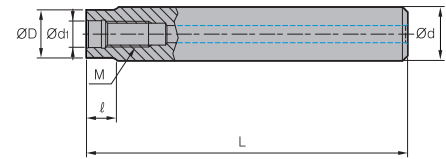

Fig. 2

(mm)

	Designation	ØD	Ød	Ød ₁	ℓ	L	M	Fig
MAT	M06-030-S10S-C-80	9.5	10	6.5	30	80	M06	1
	M06-050-S10S-C-100	9.5	10	6.5	50	100	M06	1
	M06-080-S10S-C-130	9.5	10	6.5	80	130	M06	1
	M06B-030-S10S-C-80	11.0	10	6.5	30	80	M06	1
	M06B-050-S10S-C-100	11.0	10	6.5	50	100	M06	1
	M06B-080-S10S-C-130	11.0	10	6.5	80	130	M06	1
	M08-080-S16S-C	14.5	16	8.5	80	150	M08	1
	M08-110-S16S-C	14.5	16	8.5	110	180	M08	1
	M08-150-S16S-C	14.5	16	8.5	150	250	M08	1
	M08-010-S16S-C-150	14.5	16	8.5	10	150	M08	2
	M08-010-S16S-C-180	14.5	16	8.5	10	180	M08	2
	M08-010-S16S-C-250	14.5	16	8.5	10	250	M08	2
	M10-090-S20S-C	18.0	20	10.5	90	170	M10	1
	M10-110-S20S-C	18.0	20	10.5	110	200	M10	1
	M10-175-S20S-C	18.0	20	10.5	175	300	M10	1
	M10-010-S20S-C-170	18.0	20	10.5	10	170	M10	2
	M10-010-S20S-C-200	18.0	20	10.5	10	200	M10	2
	M10-010-S20S-C-300	18.0	20	10.5	10	300	M10	2
	M12-090-S25S-C	22.5	25	12.5	90	170	M12	1
	M12-110-S25S-C	22.5	25	12.5	110	200	M12	1
	M12-175-S25S-C	22.5	25	12.5	175	300	M12	1
	M12-015-S25S-C-170	22.5	25	12.5	15	170	M12	2
	M12-015-S25S-C-200	22.5	25	12.5	15	200	M12	2
	M12-015-S25S-C-300	22.5	25	12.5	15	300	M12	2
	M16-090-S32S-C	28.5	32	17.0	90	180	M16	1
	M16-120-S32S-C	28.5	32	17.0	120	210	M16	1
	M16-175-S32S-C	28.5	32	17.0	175	300	M16	1
	M16-020-S32S-C-180	28.5	32	17.0	20	180	M16	2
M16-020-S32S-C-210	28.5	32	17.0	20	210	M16	2	
M16-020-S32S-C-300	28.5	32	17.0	20	300	M16	2	

FMR P-positive

⇒ BT30 / BT40 / BT50

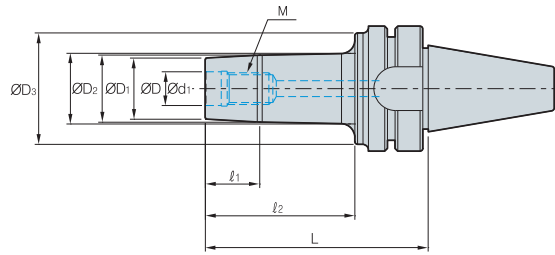

(mm)

Designation		ØD	ØD ₁	ØD ₂	ØD ₃	Ød ₁	l ₁	l ₂	L	M
BT30	MAT-M06-053	11.0	11.7	13.0	30	6.5	5	21	53	06*1.0
	MAT-M08-057	14.5	15.7	17.5	35	8.5	7	25	57	08*1.25
	MAT-M10-062	18.0	19.7	24.0	38	10.5	7	30	62	10*1.5
	MAT-M12-067	23.0	24.7	27.5	41	12.5	10	35	67	12*1.75
	MAT-M16-067	29.0	31.7	33.5	41	17.0	10	35	67	16*2.0
BT40	MAT-M06-062	11.0	11.7	14.0	40	6.5	5	25	62	08*1.0
	MAT-M06-077	11.0	11.7	14.0	40	6.5	5	40	77	06*1.0
	MAT-M06-092	11.0	11.7	14.0	40	6.5	5	55	92	06*1.0
	MAT-M08-067	14.5	15.7	19.0	44	8.5	7	30	67	08*1.25
	MAT-M08-082	14.5	15.7	19.0	44	8.5	7	45	82	08*1.25
	MAT-M08-097	14.5	15.7	19.0	44	8.5	7	60	97	08*1.25
	MAT-M10-072	18.0	19.7	23.0	50	10.5	10	35	72	10*1.5
	MAT-M10-087	18.0	19.7	23.0	50	10.5	10	50	87	10*1.5
	MAT-M10-102	18.0	19.7	23.0	50	10.5	10	65	102	10*1.5
	MAT-M12-077	23.0	24.7	30.0	55	12.5	10	40	77	12*1.75
	MAT-M12-092	23.0	24.7	30.0	55	12.5	13	55	92	12*1.75
	MAT-M12-107	23.0	24.7	30.0	55	12.5	13	70	107	12*1.75
	MAT-M16-077	29.0	31.7	37.0	55	17.0	13	40	77	16*2.0
	MAT-M16-092	29.0	31.7	37.0	55	17.0	13	55	92	16*2.0
	MAT-M16-107	29.0	31.7	37.0	55	17.0	13	70	107	16*2.0
	BT50	MAT-M06-083	11.0	11.7	15.0	40	6.5	5	35	83
MAT-M06-098		11.0	11.7	15.0	40	6.5	5	50	98	06*1.0
MAT-M06-113		11.0	11.7	15.0	40	6.5	5	65	113	06*1.0
MAT-M08-088		14.5	15.7	20.0	45	8.5	7	40	88	08*1.25
MAT-M08-103		14.5	15.7	20.0	45	8.5	7	55	103	08*1.25
MAT-M08-118		14.5	15.7	20.0	45	8.5	7	70	118	08*1.25
MAT-M10-093		18.0	19.7	25.0	55	10.5	10	45	93	10*1.5
MAT-M10-113		18.0	19.7	25.0	55	10.5	10	65	113	10*1.5
MAT-M10-128		18.0	19.7	25.0	55	10.5	10	80	128	10*1.5
MAT-M12-103		23.0	24.7	33.0	65	12.5	10	55	103	12*1.75
MAT-M12-118		23.0	24.7	33.0	65	12.5	13	70	118	12*1.75
MAT-M12-133		23.0	24.7	33.0	65	12.5	13	85	133	12*1.75
MAT-M16-103		29.0	31.7	41.0	85	17.0	13	55	103	16*2.0
MAT-M16-118		29.0	31.7	41.0	85	17.0	13	70	118	16*2.0
MAT-M16-133	29.0	31.7	41.0	85	17.0	13	85	133	16*2.0	

⇒ HSK63A / HSK100A

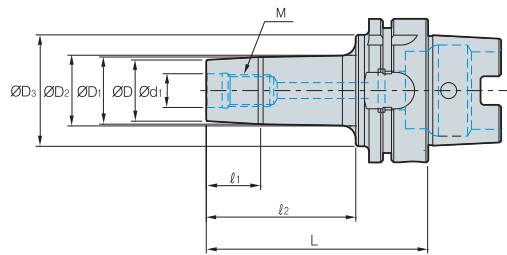

(mm)

Designation		ØD	ØD ₁	ØD ₂	ØD ₃	Ød ₁	l ₁	l ₂	L	M
HSK63A	MAT-M06-061	11.0	11.7	27.0	40	6.5	5	25	61	06*1.0
	MAT-M06-076	11.0	11.7	27.0	40	6.5	5	40	76	06*1.0
	MAT-M06-091	11.0	11.7	27.0	40	6.5	5	55	91	06*1.0
	MAT-M08-066	14.5	15.7	30.5	44	8.5	7	30	66	08*1.25
	MAT-M08-081	14.5	15.7	30.5	44	8.5	7	45	81	08*1.25
	MAT-M08-096	14.5	15.7	30.5	44	8.5	7	60	96	08*1.25
	MAT-M10-071	18.0	19.7	34.0	50	10.5	10	35	71	10*1.5
	MAT-M10-086	18.0	19.7	34.0	50	10.5	10	50	86	10*1.5
	MAT-M10-101	18.0	19.7	34.0	50	10.5	10	65	101	10*1.5
	MAT-M12-076	23.0	24.7	36.5	55	12.5	10	40	76	12*1.75
	MAT-M12-091	23.0	24.7	36.5	55	12.5	13	55	91	12*1.75
	MAT-M12-106	23.0	24.7	36.5	55	12.5	13	70	106	12*1.75
	MAT-M16-076	29.0	31.7	38.5	55	17.0	13	40	76	16*2.0
	MAT-M16-091	29.0	31.7	38.5	55	17.0	13	55	91	16*2.0
MAT-M16-106	29.0	31.7	38.5	55	17.0	13	70	106	16*2.0	
HSK100A	MAT-M06-074	11.0	11.7	15.0	40	6.5	5	35	74	06*1.0
	MAT-M06-089	11.0	11.7	15.0	40	6.5	5	50	89	06*1.0
	MAT-M06-104	11.0	11.7	15.0	40	6.5	5	65	104	06*1.0
	MAT-M08-079	14.5	15.7	20.0	45	8.5	7	40	79	08*1.25
	MAT-M08-094	14.5	15.7	20.0	45	8.5	7	55	94	08*1.25
	MAT-M08-109	14.5	15.7	20.0	45	8.5	7	70	109	08*1.25
	MAT-M10-084	18.0	19.7	25.0	55	10.5	10	45	84	10*1.5
	MAT-M10-104	18.0	19.7	25.0	55	10.5	10	65	104	10*1.5
	MAT-M10-119	18.0	19.7	25.0	55	10.5	10	80	119	10*1.5
	MAT-M12-094	23.0	24.7	33.0	65	12.5	10	55	94	12*1.75
	MAT-M12-109	23.0	24.7	33.0	65	12.5	13	70	109	12*1.75
	MAT-M12-124	23.0	24.7	33.0	65	12.5	13	85	124	12*1.75
	MAT-M16-094	29.0	31.7	41.0	85	17.0	13	55	94	16*2.0
	MAT-M16-109	29.0	31.7	41.0	85	17.0	13	70	109	16*2.0
	MAT-M16-124	29.0	31.7	41.0	85	17.0	13	85	124	16*2.0

www.korloy.com



Head Office: Holystar B/D, 1350, Nambusunhwan-ro, Geumcheon-gu, Seoul, 08536, Korea

Tel: +82-2-522-3181 Fax: +82-2-522-3184, +82-2-3474-4744 Web: www.korloy.com E-mail: sales.khq@korloy.com

New Company Building (Expected to move on June 2022): 326, Seocho-daero, Seocho-gu, Seoul, Republic of Korea

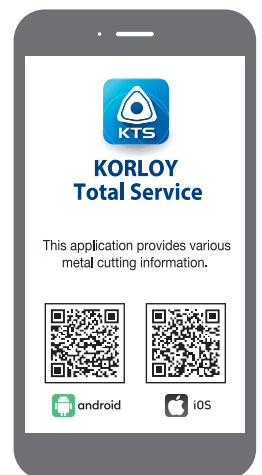

KORLOY AMERICA

620 Maple Avenue, Torrance, CA 90503, USA

Tel: +1-310-782-3800 Toll Free: +1-888-711-0001 Fax: +1-310-782-3885

E-mail: sales.kai@korloy.com

KORLOY INDIA

Plot No. 415, Sector 8, IMT Manesar, Gurgaon 122051, Haryana, India

Tel: +91-124-4391790 Fax: +91-124-4050032

E-mail: sales.kip@korloy.com

KORLOY TURKEY

Serifali Mahallesi, Burhan Sokak NO: 34

Dudullu OSB/Umraniye/Istanbul, 34775, Turkey

Tel: +90-216-415-8874 E-mail: sales.ktl@korloy.com

KORLOY RUSSIA

Krasivy Dom office No. 305, Bld. 5, Novovladykinskiy proezd 8, 127106,

Moscow, Russia

Tel: +7-495-280-1458 Fax: +7-495-280-1459 E-mail: sales.krc@korloy.com

KORLOY FACTORY INDIA

Plot No. 415, Sector 8, IMT Manesar, Gurgaon 122051, Haryana, India

Tel: +91-124-4391790 Fax: +91-124-4050032

E-mail: pro.kim@korloy.com

KORLOY EUROPE

Gablonzer Str. 25-27, 61440 Oberursel, Germany

Tel: +49-6171-277-83-0 Fax: +49-6171-277-83-59

E-mail: sales.keg@korloy.com

KORLOY BRASIL

Av. Aruana 280, conj.12, WLC, Alphaville, Barueri,

CEP06460-010, SP, Brasil

Tel: +55-11-4193-3810 E-mail: sales.kbl@korloy.com

KORLOY CHILE

Av. Providencia 1650, Office 1009, 7500027

Providencia-Santiago, Chile

Tel: +56-229-295-490 E-mail: sales.kcs@korloy.com

KORLOY MEXICO

Queretaro, Mexico

E-mail: sales.kml@korloy.com