

RM3

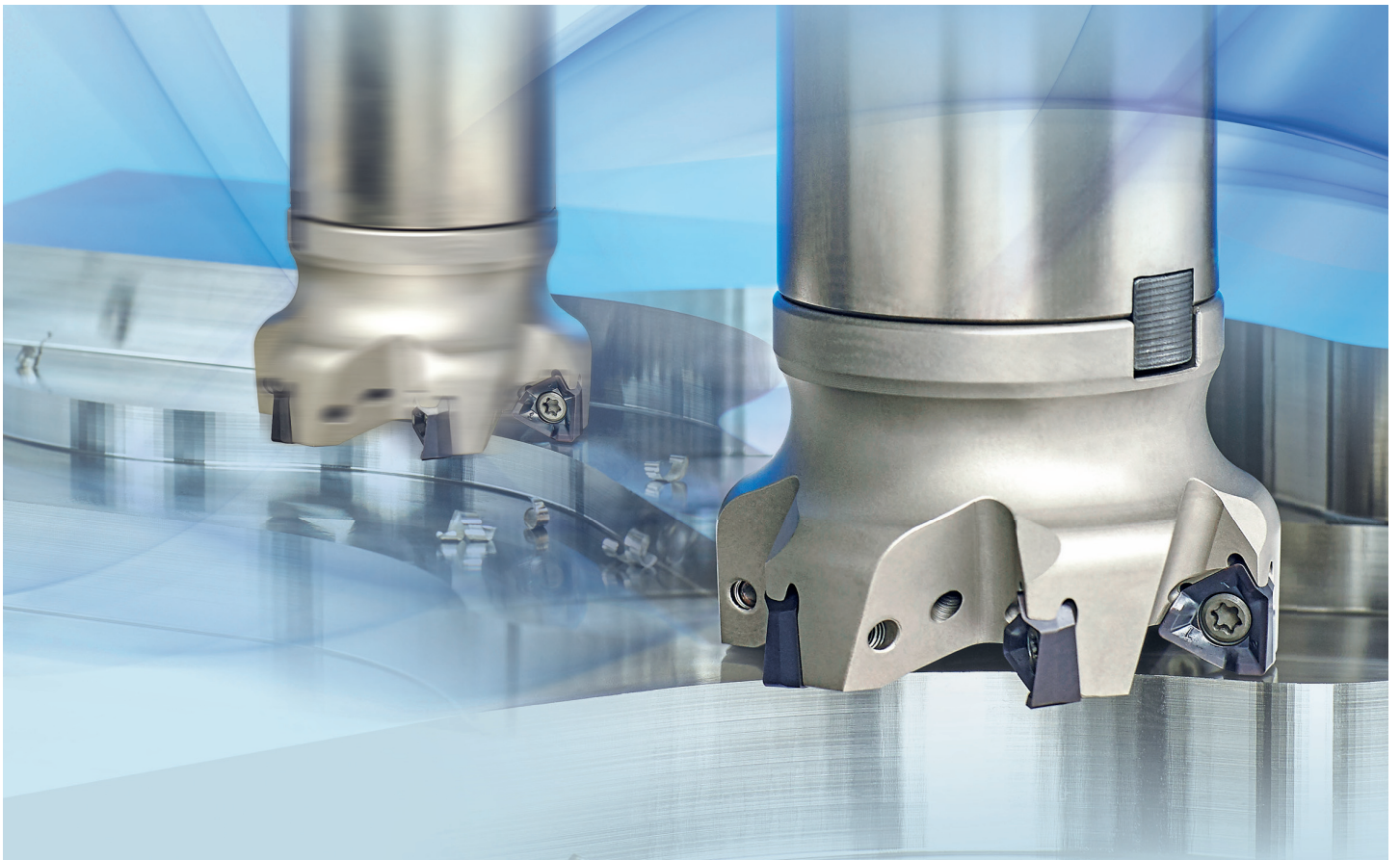

Multi Functional Shoulder Milling Tool for Higher Productivity

- ▣ **High Quality**
True perpendicular shouldering operation
- ▣ **Excellent Productivity**
Strong thick insert and 3-face clamping for stable milling even in the toughest conditions
- ▣ **Great Value for Money**
Reduced tool cost thanks to optimized manufacturing process and excellent tool life



Multi Functional Shouldering Tool RM3

In this industry, requirements such as reducing manufacturing cost and improving quality are constantly in demand. This means cutting tools for mold making would have to achieve both factors. Tools must achieve high productivity and quality in a variety of applications, notably in the mold making industry, in various applications: shouldering, facing, slotting, plunging, etc. If cutting tools should have to be replaced with every application, both productivity and cost efficiency would get worse. This led KORLOY to develop the RM3. A tool specifically engineered for true perpendicular shouldering, with multi-functional capabilities.

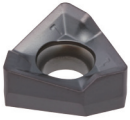

Insert



Cutter



Shank

To use a single tool for various applications requires not only sharp cutting action but high rigidity and stable clamping. Poor cutting performance leads to excessive noise and burrs, and deteriorates both the perpendicularity and the surface finish. Low rigidity and unstable clamping cause vibration during operations leading to insert chipping or breakage, which shortens the tool life.

The RM3 solves all these problems and delivers higher machining stability and excellent results in quality. This 3 corner insert shouldering tool exhibits a proprietary insert design with high rake angle chip breakers & cutting edges for sharp cutting action and low cutting resistance. It additionally features a holder rigidity 2 times stronger than the existing tools, which allows a stable machining even in the toughest cutting conditions. There were lots of actual test reports that the RM3 significantly improved our customers' cycle time thanks to its high rigidity and clamping system in operations such as shouldering, ramping, facing, slotting and plunging. Even in high feed milling applications, the RM3 showed no sign of tool failure.

The RM3 also takes advantage of the true perpendicularity that largely improves surface finish. A variety of grades are prepared for machining applications in steel, cast iron, hard-to-cut materials and more. RM3 markets itself as a versatile leading milling tool that meets demanding performance and capacity requirements.

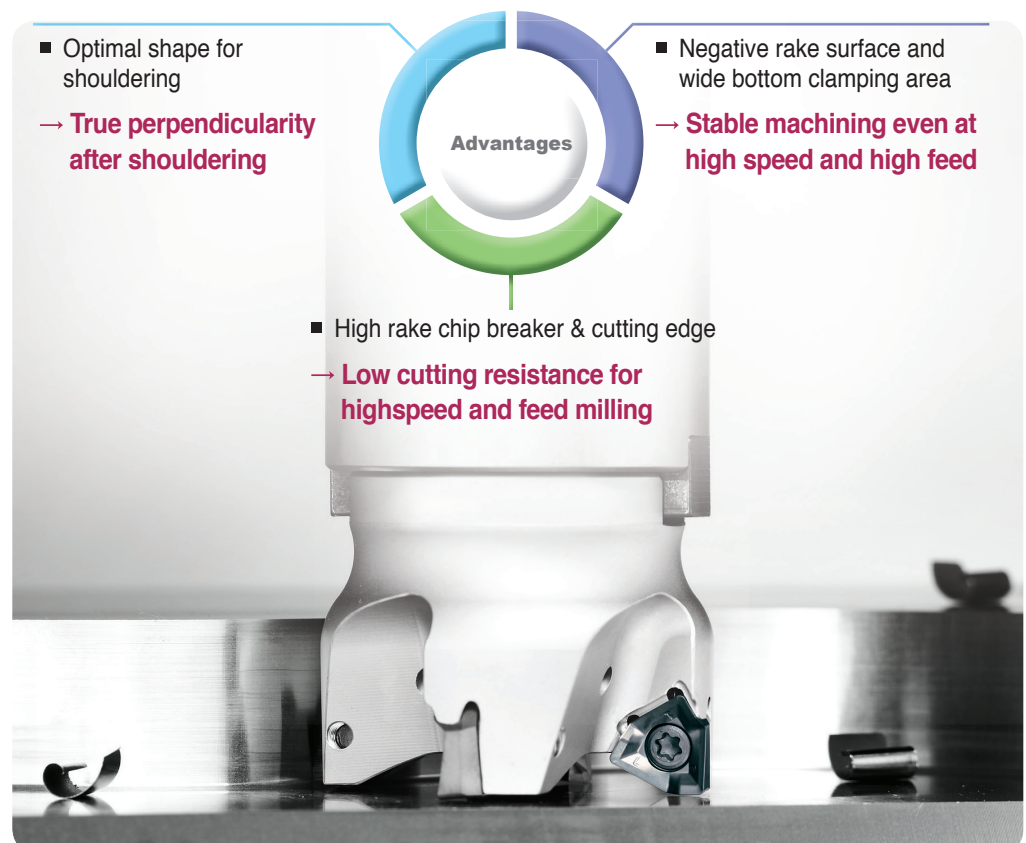

RM3

- **High Quality**
 - True 90° shouldering operation
- **Excellent Productivity**
 - Strong thick insert and 3-face clamping ensures stable machining even in tough cutting conditions
- **Great Value for Money**
 - Longer tool life due to optimized cutter and insert geometry



Insert Features

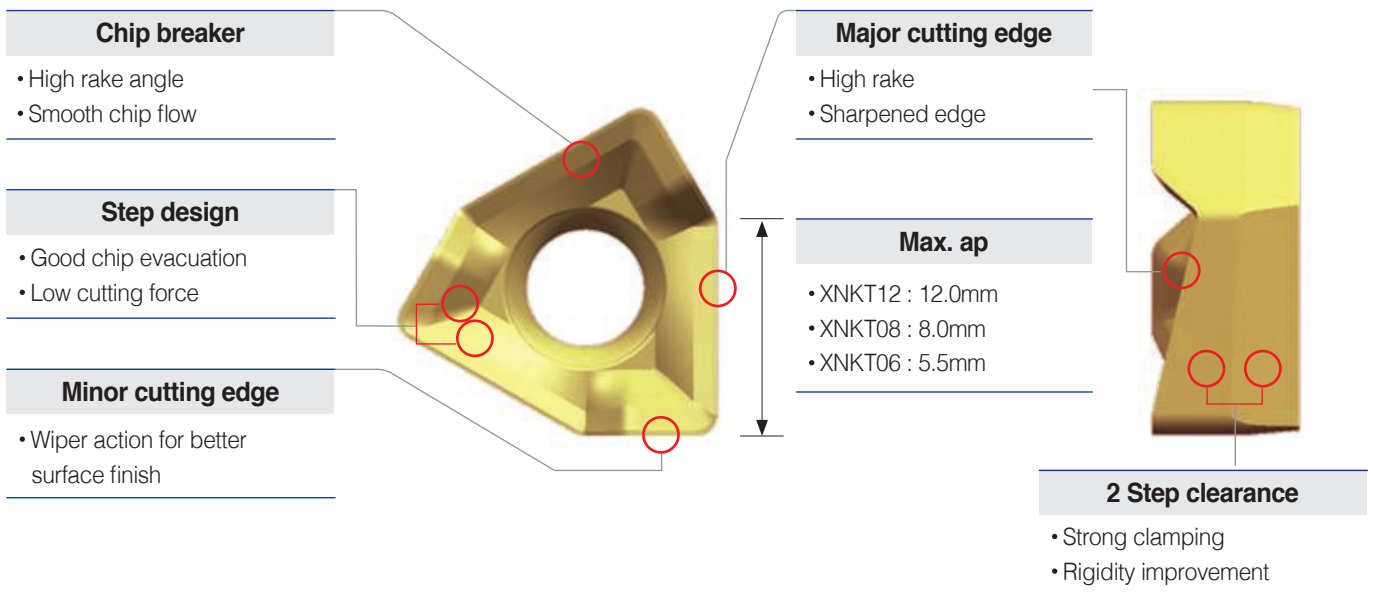

Chip Breaker Features

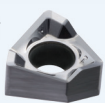
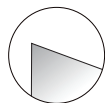
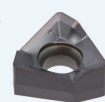
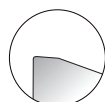
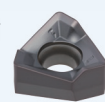
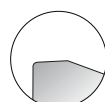
Chip breaker	Cutting edge	Applications	Features
<ul style="list-style-type: none"> • Chip breaker <p>MA</p> 		Aluminum	<ul style="list-style-type: none"> ■ MA : Milling Aluminum ■ Sharp cutting edge and buffed top face for an excellent chip flow and welding resistance in aluminum machining
<ul style="list-style-type: none"> • Chip breaker <p>ML</p> 		Light	<ul style="list-style-type: none"> ■ ML : Milling Light ■ Sharp cutting edge for hard-to-cut materials ■ Low cutting force
<ul style="list-style-type: none"> • Chip breaker <p>MM</p> 		General	<ul style="list-style-type: none"> ■ MM : General shouldering operations ■ 1st recommendation

RM3

➔ Cutter Features

Through coolant system

- Through coolant system providing a longer tool life due to direct cooling injection onto the cutting edge of the insert.

Excellent chip evacuation

- Wide chip pocket
- Simple Screw-on system

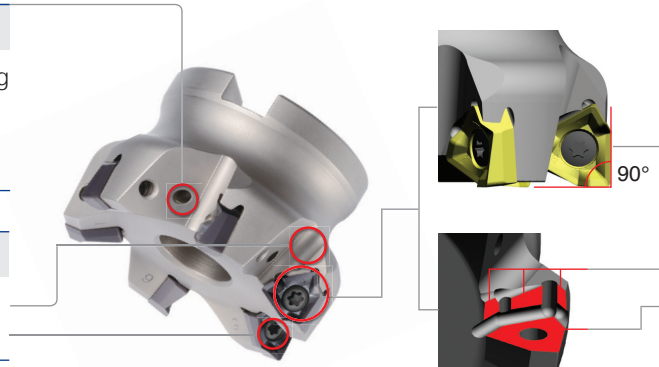

True perpendicularity

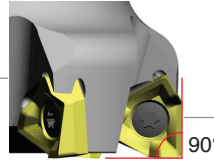

Strong clamping

- 3-face clamping seat
- Full flat bottom seat

➔ Cutting Performance

[Cutting edge]

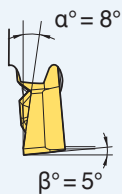

- True positive clearance due to high rake angle
→ **Excellent machineability**

Cutting Load

- Workpiece 42CrMo4 (200HB)
- Cutting conditions $vc(m/min) = 250$, $fz(mm/t) = 0.1$, $ap(mm) = 3.0$, dry
- Tools
Insert XNKT080508PNSR-MM (PC5300)
Cutter RM3PCM4063HR-M

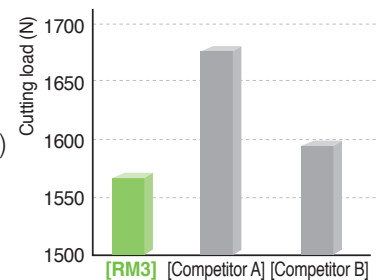

Perpendicularity

- Workpiece 42CrMo4 (200HB)
- Cutting conditions $vc(m/min) = 200$, $fz(mm/t) = 0.1$, $ap(mm) = 7.0 \times 3$ pass, $ae(mm) = 10.0$, dry
- Tools
Insert XNKT080508PNSR-MM (PC5300)
Cutter RM3PCM4063HR-M

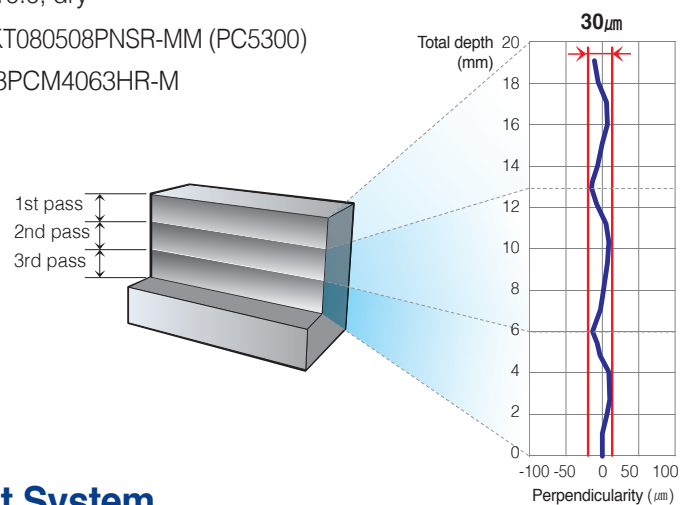

➔ Through Coolant System

- Exclusive through coolant bolt and supporting arbor required
- Effective coolant distribution directly onto the cutting edges

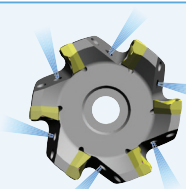

⇒ Grades Application Guidelines

Workpiece		P		M	K	N
		Carbon steel	Alloy steel	Stainless steel	Cast iron	Aluminum
Chip breaker	First choice	MM	MM	ML	ML	MA
	Second choice	ML	ML	-	MM	-
Grade	High speed machining	PC3600	PC3600	PC5300	PC6510	H01
	General machining	PC5400	PC5300	PC5400	PC5300	H01
	Interrupted machining	PC5400	PC5400	PC5400	PC5400	H01

⇒ Recommended Cutting Conditions

▶ RM3 3000 Type

Workpiece	Grade	Cutting conditions				Available inserts	Cutting conditions			
		vc (m/min)	fz (mm/t)	max ap(mm)	vc (m/min)		fz (mm/t)	max ap(mm)	Available inserts	
P	steel	PC3600	160~270	0.25~0.05	5.5	XNKT0604□□ PN□R-MM	160~270	0.2~0.05	5.5	XNKT0604□□ PN□R-ML
		PC5300	150~240	0.25~0.05	5.5		150~240	0.25~0.05	5.5	
		PC5400	130~210	0.25~0.05	5.5		130~210	0.25~0.05	5.5	
M	Stainless steel	PC5300	90~150	0.2~0.05	5.5		90~150	0.1~0.05	5.5	
		PC5400	70~120	0.2~0.05	5.5		70~120	0.1~0.05	5.5	
K	Cast iron	PC6510	140~230	0.3~0.08	5.5		140~230	0.25~0.08	5.5	
		PC5300	120~200	0.3~0.08	5.5		120~200	0.25~0.08	5.5	

* Maximum cutting condition : vc = 350m/min, fz = 0.5mm/t according to cutting environment

▶ RM3 4000 Type

Workpiece	Grade	Cutting conditions				Available inserts	Cutting conditions				
		vc (m/min)	fz (mm/t)	max ap(mm)	vc (m/min)		fz (mm/t)	max ap(mm)	Available inserts		
P	steel	PC3600	160~270	0.3~0.05	8.0	XNKT0805□□ PN□R-MM	160~270	0.25~0.05	8.0	XNKT0805□□ PN□R-ML	
		PC5300	150~240	0.3~0.05	8.0		150~240	0.25~0.05	8.0		
		PC5400	130~210	0.3~0.05	8.0		130~210	0.25~0.05	8.0		
M	Stainless steel	PC5300	90~150	0.25~0.05	8.0		90~150	0.2~0.05	8.0		
		PC5400	70~120	0.25~0.05	8.0		70~120	0.2~0.05	8.0		
K	Cast iron	PC6510	140~230	0.35~0.08	8.0		140~230	0.3~0.08	8.0		
		PC5300	120~200	0.35~0.08	8.0		120~200	0.3~0.08	8.0		
N	Aluminum	H01	400~1200	0.4~0.1	8.0		XNCT0805□□PNFR-MA				

* Maximum cutting condition : vc = 350m/min, fz = 0.5mm/t according to cutting environment

▶ RM3 5000 Type

Workpiece	Grade	Cutting conditions				Available inserts	Cutting conditions						
		vc (m/min)	fz (mm/t)	max ap(mm)	vc (m/min)		fz (mm/t)	max ap(mm)	Available inserts				
P	steel	PC3600	160~270	0.3~0.05	12.0	XNKT1206□□ PN□R-MM	160~270	0.25~0.05	12.0	XNKT1206□□ PN□R-ML			
		PC5300	150~240	0.3~0.05			150~240	0.25~0.05					
		PC5400	130~210	0.3~0.05			130~210	0.25~0.05					
M	Stainless steel	PC5300	90~150	0.25~0.05			90~150	0.2~0.05					
		PC5400	70~120	0.25~0.05			70~120	0.2~0.05					
K	Cast iron	PC6510	140~230	0.35~0.08			140~230	0.3~0.08					
		PC5300	120~200	0.35~0.08			120~200	0.3~0.08					
N	Aluminum	H01	400~1200	0.4~0.1			12.0	XNCT1206□□PN□R-MA					

* Maximum cutting condition : vc = 350m/min, fz = 0.5mm/t according to cutting environment

RM3

⇒ Max Step in plunging

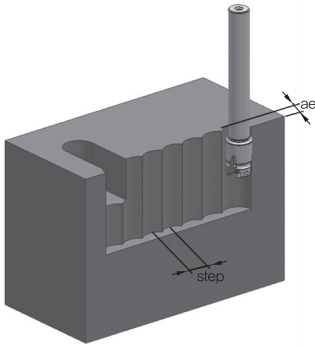

ae	Cutter diameter(Ø)											
	Ø20	Ø21	Ø25	Ø26	Ø32	Ø33	Ø40	Ø50	Ø63	Ø80	Ø100	Ø125
	Max step (mm)											
1	8.5	8.9	9.7	10	11.1	11.3	12.4	14	15.7	17.7	19.9	22.2
2	12	12.3	13.5	13.8	15.4	15.7	17.4	19.5	22	24.9	28	31.3
3	-	-	-	-	-	-	21	23.7	26.8	30.3	34.1	38.2

⇒ Ramping and Helical cutting

1. Ramping

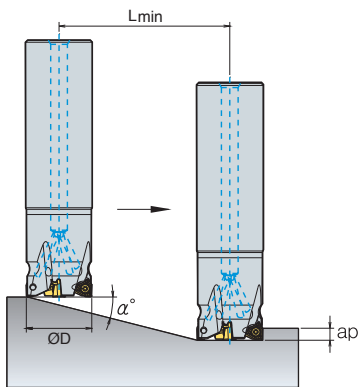

2. Helical cutting for blind hole

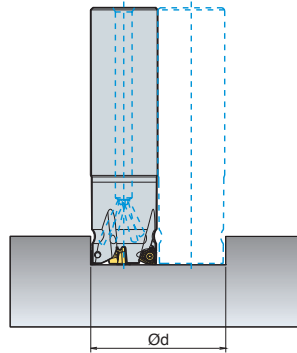

3. Helical cutting for through hole

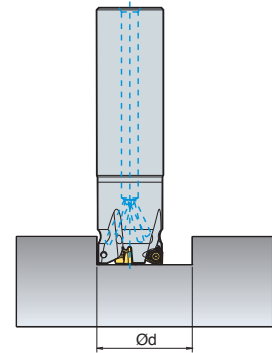

Type	Tool Dia. ØD(mm)	1. Ramping		2. Helical cutting for blind hole				3. Helical cutting for through hole	
		α°	Lmin(mm)	Minimum Hole Diameter Ød(mm)	Maximum Pitch(mm)	Maximum Hole Diameter Ød(mm)	Maximum Pitch(mm)	Minimum Hole Diameter Ød(mm)	Maximum Pitch(mm)
3000 type	20	15.5	19.8	36.5	5.5	38.5	5.5	33.0	5.5
	21	14.0	22.1	38.5	5.5	40.5	5.5	35.0	5.5
	25	10.0	31.2	46.5	5.5	48.5	5.5	43.0	5.5
	26	9.5	32.9	48.34	5.5	51.0	5.5	45.0	5.5
	32	6.5	48.3	60.5	5.5	62.5	5.5	59.0	5.5
	33	6.0	52.3	62.5	5.5	64.5	5.5	59.0	5.5
	40	4.5	69.9	46.5	5.5	78.5	5.5	73.0	5.5
	50	3.5	89.9	96.5	5.5	98.5	5.5	93.0	5.5
	63	2.5	126.0	122.5	5.5	124.5	5.5	119.0	5.5
	80	2.0	157.5	156.5	5.5	158.5	5.5	153.0	5.5
4000 type	100	1.5	210.0	194.5	5.5	198.5	5.5	193.0	5.5
	125	1.0	315.1	246.5	5.5	248.5	5.5	243.0	5.5
	25	24.0	18.0	44.5	8.0	48.0	8.0	38.5	8.0
	32	13.0	34.7	58.5	8.0	62.0	8.0	52.5	8.0
	33	12.0	37.6	60.02	8.0	64.4	8.0	54.5	8.0
	40	8.5	53.5	74.5	8.0	78.0	8.0	68.5	8.0
	50	6.0	76.1	94.5	8.0	98.0	8.0	88.5	8.0
	63	4.0	114.4	120.5	8.0	124.0	8.0	114.5	8.0
5000 type	80	3.0	152.6	154.5	8.0	158.0	8.0	148.5	8.0
	100	2.0	229.1	194.5	8.0	198.0	8.0	188.5	8.0
	125	1.5	305.5	244.5	7.7	248.0	7.8	238.5	7.7
	80	5.5	124.6	153.5	12.0	158.0	12.0	146.5	12.0
	100	4.5	152.5	193.5	12.0	198.0	12.0	159.5	12.0
	125	3.5	196.2	242.5	12.0	248.0	12.0	236.5	12.0

* Please be sure to use cutting oil or air for ramping and helical machining
 $L_{min} = ap / \tan(\alpha^\circ)$

⇒ Cutting Performance

• Surface finish
(shouldering, side face)

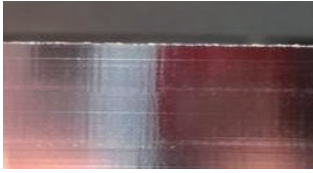

[RM3]

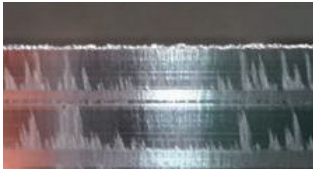

[Competitor]

Carbon steel (C45, HB200)

- Cutting conditions Competitor $vc(m/min) = 270$, $fz(mm/t) = 0.2$, $ap(mm) = 6.0 \times 4$ pass, $ae(mm) = 5.0$
RM3 $vc(m/min) = 270$, $fz(mm/t) = 1.0$, $ap(mm) = 3.0 \times 8$ pass, $ae(mm) = 5.0$
- Application area Shouldering
- Tools Insert XNKT080508PNSR-MM (PC5300) Cutter RM3PCM4063HR-M

RM3 **122.8 cm³/min**

Competitor 49.1cm³/min
Chip removal rate(cm³/min)

2.5times more

RM3 **3.9min**

Competitor 9.8min
Machining time(min)

60% less

• Surface roughness



[RM3]



[Competitor]

Alloy steel (42CrMo4, HB200)

- Cutting conditions Competitor $vc(m/min) = 250$, $fz(mm/t) = 0.125$, $ap(mm) =$ Finishing 0.5 / Roughing 7.0
RM3 $vc(m/min) = 250$, $fz(mm/t) = 0.125$, $ap(mm) =$ Finishing 0.5 / Roughing 7.0
- Application area Facing
- Tools Insert XNKT080508PNSR-MM (PC5300) Cutter RM3PCM4063HR-M

RM3 **1500ea**

Competitor 1050ea
Workpiece(ea)

1.4times more

RM3 **1.81 μm**

Competitor 3.29 μm
Surface roughness(R_{max})

45% less

⇒ Available Inserts

Insert Shape	Designation	Cutter	Coated					Uncoated		Dimensions (mm)						Configuration
			PC3600	PC5300	PC5400	PC6510	H01	l	d	t	r	d ₁	a			
	XNKT 080504PNFR-MA 080508PNFR-MA 080512PNFR-MA 080520PNFR-MA 120608PNFR-MA	4000 type	-	-	-	-	-	8.2	10.0	5.5	0.4	4.5	2.9			
			-	-	-	-	●	8.2	10.0	5.5	0.8	4.5	2.9			
			-	-	-	-	-	8.2	10.0	5.5	1.2	4.5	2.9			
			-	-	-	-	-	8.2	10.0	5.5	2.0	4.5	2.9			
		5000 type	-	-	-	-	-	12.0	13.0	6.5	0.8	5.5	3.5			
	XNKT 060405PNER-ML 080504PNER-ML 080508PNER-ML 080512PNER-ML 080516PNER-ML 080520PNER-ML 120608PNER-ML 120612PNER-ML 120616PNER-ML 120620PNER-ML	3000 type	●	●	●	●	-	5.7	6.5	4.0	0.5	3.4	1.8			
		4000 type	-	-	-	-	-	8.2	10.0	5.5	0.4	4.5	2.9			
			-	-	-	-	-	8.2	10.0	5.5	0.8	4.5	2.9			
			-	-	-	-	-	8.2	10.0	5.5	1.2	4.5	2.9			
			-	-	-	-	-	8.2	10.0	5.5	1.6	4.5	2.9			
		5000 type	-	-	-	-	-	8.2	10.0	5.5	2.0	4.5	2.9			
			-	-	-	-	-	12.0	13.0	6.5	0.8	5.5	3.5			
			-	-	-	-	-	12.0	13.0	6.5	1.2	5.5	3.5			
			-	-	-	-	-	12.0	13.0	6.5	1.6	5.5	3.5			
-	-		-	-	-	12.0	13.0	6.5	2.0	5.5	3.5					
	XNKT 060405PNSR-MM 080504PNSR-MM 080508PNSR-MM 080512PNSR-MM 080516PNSR-MM 080520PNSR-MM 120608PNSR-MM 120612PNSR-MM 120616PNSR-MM 120620PNSR-MM	3000 type	●	●	●	●	-	5.7	6.5	4.0	0.5	3.4	1.8			
		4000 type	-	-	-	-	-	8.2	10.0	5.5	0.4	4.5	2.9			
			●	●	●	●	-	8.2	10.0	5.5	0.8	4.5	2.9			
			-	-	-	-	-	8.2	10.0	5.5	1.2	4.5	2.9			
			-	-	-	-	-	8.2	10.0	5.5	1.6	4.5	2.9			
		5000 type	-	-	-	-	-	8.2	10.0	5.5	2.0	4.5	2.9			
			-	-	-	-	-	12.0	13.0	6.5	0.8	5.5	3.5			
			-	-	-	-	-	12.0	13.0	6.5	1.2	5.5	3.5			
			-	-	-	-	-	12.0	13.0	6.5	1.6	5.5	3.5			
			-	-	-	-	-	12.0	13.0	6.5	2.0	5.5	3.5			
-	-		-	-	-	12.0	13.0	6.5	2.0	5.5	3.5					

RM3

RM3PC(M)3000

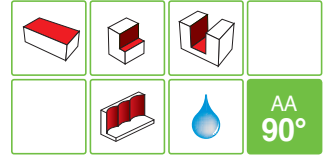
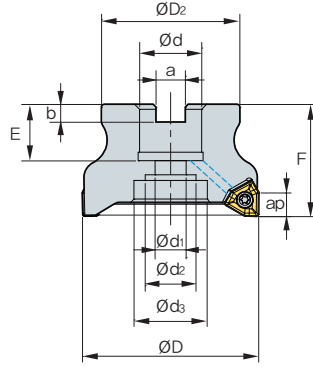

*AR : -5°
*RR : -9°-6°

(mm)

Designation			ØD	ØD ₂	Ød	Ød ₁	Ød ₂	Ød ₃	a	b	E	F	ap	
RM3PCM	3040HR	5	40	35	16	9	14	-	8.4	5.6	16	40	5.5	0.2
	3040HR-M	6	40	35	16	9	14	-	8.4	5.6	16	40	5.5	0.2
	3050HR	6	50	41	22	11	18	-	10.4	6.3	20	40	5.5	0.3
	3050HR-M	7	50	41	22	11	18	-	10.4	6.3	20	40	5.5	0.3
	3063HR	7	63	49	22	11	18	-	10.4	6.3	20	40	5.5	0.49
	3063HR-M	8	63	49	22	11	18	-	10.4	6.3	20	40	5.5	0.49
RM3PC (RM3PCM)	3080HR	8	80	57	25.4(27)	14	25	35(35)	9.5(12.4)	6(7)	25(23)	50	5.5	0.87
	3080HR-M	10	80	57	25.4(27)	14	25	35(35)	9.5(12.4)	6(7)	25(23)	50	5.5	0.88

()Metric Size

Available Inserts

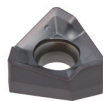

XNKT-ML

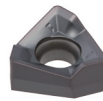

XNKT-MM

Designation	Cermet		Coated									Uncoated		
	CN2000	CN30	NCM325	NC5330	PC3500	PC3600	PC3545	PC9530	PC6510	PC5300	PC5400	A30	G10E	H01
XNKT 060405PNER-ML						●				●	●	●		
060405PNSR-MM						●				●	●	●		

Available Arbors

Designation	Available Arbors	
	RM3PC	RM3PCM
RM3PCM 3040HR	-	BT□□-FMC16-□□
3040HR-M		
3050HR		
3050HR-M		
3063HR		
3063HR-M		
RM3PC (RM3PCM) 3080HR	BT□□-FMA25.4-□□	BT□□-FMC27-□□
3080HR-M		

Parts

Specification	Screw	Wrench
Ø40 ~ Ø80	FTNA0306	TW09S

RM3PC(M)4000

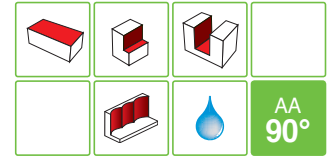
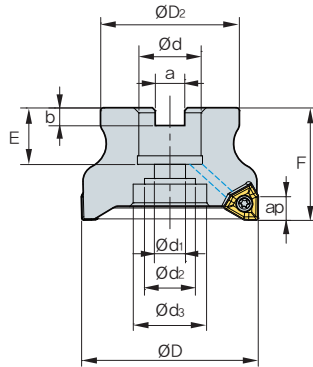

AR : -5°
RR : -8° ~ -6°

(mm)

Designation		ØD	ØD ₂	Ød	Ød ₁	Ød ₂	Ød ₃	a	b	E	F	ap	$\frac{m}{kg}$	
RM3PCM	4040HR	3	40	35	16	16	14	-	8.4	5.6	19	40	8.0	0.19
	4040HR-M	4	40	35	16	16	14	-	8.4	5.6	19	40	8.0	0.19
	4050HR	4	50	42	22	22	18	-	10.4	6.3	20	40	8.0	0.28
	4050HR-M	5	50	42	22	22	18	-	10.4	6.3	20	40	8.0	0.29
	4063HR	5	63	49	22	22	18	-	10.4	6.3	20	40	8.0	0.54
	4063HR-M	6	63	49	22	22	18	-	10.4	6.3	20	40	8.0	0.53
RM3PC (RM3PCM)	4080HR	5	80	57	25.4(27)	25.4(27)	20	35(35)	9.5(12.4)	6(7)	25(23)	50	8.0	1.08
	4080HR-M	7	80	57	25.4(27)	25.4(27)	20	35(35)	9.5(12.4)	6(7)	25(23)	50	8.0	1.06
	4100HR	7	100	67	31.75(32)	31.75(32)	26	42(42)	12.7(14.4)	8(8)	33(25)	63(50)	8.0	1.68
	4100HR-M	8	100	67	31.75(32)	31.75(32)	26	42(42)	12.7(14.4)	8(8)	33(25)	63(50)	8.0	1.67
	4125HR	8	125	90	38.1(40)	38.1(40)	32	52(52)	15.9(16.4)	9(10)	38(29)	63	8.0	3.45
	4125HR-M	10	125	90	38.1(40)	38.1(40)	32	52(52)	15.9(16.4)	9(10)	38(29)	63	8.0	3.45

() Metric Size

Available Inserts



XNCT-MA



XNKT-ML



XNKT-MM

Designation	Cermet		Coated									Uncoated		
	CN2000	CN30	NCM325	NC5330	PC3500	PC3600	PC3545	PC9530	PC6510	PC5300	PC5400	A30	G10E	H01
XNCT	080504PNFR-MA													
	080508PNFR-MA													●
	080512PNER-MA													
	080520PNFR-MA													
XNKT	080508PNER-ML					●				●	●			
	080508PNSR-MM					●				●	●			
	080512PNER-ML													
	080512PNSR-MM													
	080516PNER-ML													
	080516PNSR-MM													
	080520PNER-ML													
	080520PNSR-MM													

Available Arbors

Designation	Available Arbors	
	RM3PC	RM3PCM
RM3PC (RM3PCM)	4040HR	-
	4050HR	-
	4063HR	-
	4080HR	BT□□-FMA25.4-□□
	4100HR	BT□□-FMA31.75-□□
	4125HR	BT□□-FMA38.1-□□
		BT□□-FMC16-□□
		BT□□-FMC22-□□
		BT□□-FMC27-□□
		BT□□-FMC32-□□
		BT□□-FMC40-□□

Parts

Specification	Screw	Wrench
Ø40 ~ Ø125	FTNA0408	TW15S

RM3

RM3PC(M)5000

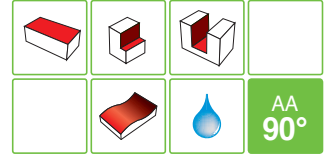
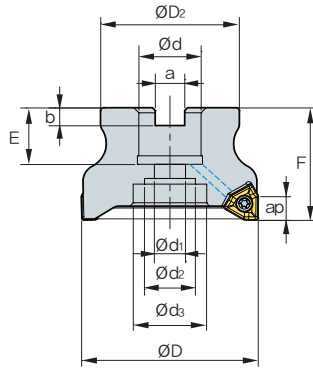

AA 90°
AR: -5°
RR: -7°

(mm)

Designation		⊙	ØD	ØD ₂	Ød	Ød ₁	Ød ₂	Ød ₃	a	b	E	F	ap	
RM3PC (RM3PCM)	5080HR	5	80	57	25.4(27)	14	20	35	9.5(12.4)	6(7)	24(23)	50	12.0	0.84
	5080HR-M	7	80	57	25.4(27)	14	20	35	9.5(12.4)	6(7)	24(23)	50	12.0	0.84
	5100HR	7	100	67	31.75(32)	18	28	45	12.7(14.4)	8(8)	32(25)	63	12.0	1.76
	5100HR-M	8	100	67	31.75(32)	18	28	45	12.7(14.4)	8(8)	32(25)	63	12.0	1.76
	5125HR	8	125	90	38.1(40)	22	32	52	15.9(16.4)	9(10)	38(30)	63	12.0	2.70
	5125HR-M	10	125	90	38.1(40)	22	32	52	15.9(16.4)	9(10)	38(30)	63	12.0	2.70

() Metric Size

Available Inserts



XNCT-MA



XNKT-ML

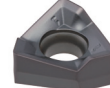

XNKT-MM

Designation	Cermet		Coated									Uncoated		
	CN2000	CN30	NCM325	NC5330	PC3500	PC3600	PC3545	PC9530	PC6510	PC5300	PC5400	A30	G10E	H01
XNCT 120608PNFR-MA														
XNKT 120608PNSR-MM														
120608PNER-ML														
120612PNSR-MM														
120612PNER-ML														
120616PNSR-MM														
120616PNER-ML														
120620PNSR-MM														
120620PNER-ML														

Available Arbors

Designation	Available Arbors	
	RM3PC	RM3PCM
RM3PC 5080HR	BT□□-FMA25.4-□□	BT□□-FMC27-□□
(RM3PCM) 5100HR	BT□□-FMA31.75-□□	BT□□-FMC32-□□
5125HR	BT□□-FMA38.1-□□	BT□□-FMC40-□□

Parts

Specification	Screw	Wrench
Ø80 ~ Ø125	FTNA0511	TW20-100

RM3PS3000



AA 90°
 *AR : 5°
 *RR : 16°~9°

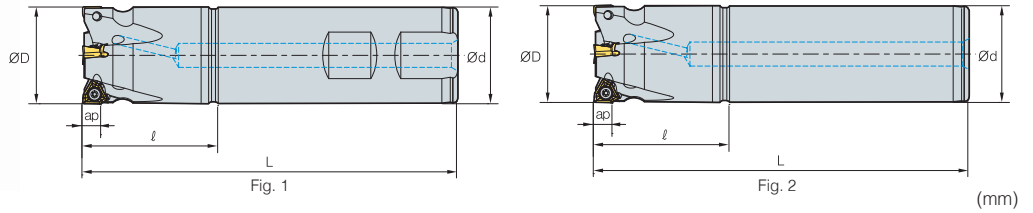

Designation		⊙	ØD	Ød	ℓ	L	ap	kg	Fig.
RM3PS	3020HR-2S20	2	20	20	35	100	5.5	0.21	2
	3020HR-2L20	2	20	20	35	200	5.5	0.43	1
	3021HR-2S20	2	21	20	30	100	5.5	0.21	2
	3021HR-2L20	2	21	20	30	200	5.5	0.43	1
	3025HR-3S20	2	25	20	35	115	5.5	0.27	2
	3025HR-3L20	2	25	20	35	200	5.5	0.46	1
	3025HR-3S25	3	25	25	40	115	5.5	0.36	2
	3025HR-3L25	3	25	25	40	200	5.5	0.66	1
	3026HR-2S20	2	26	20	35	115	5.5	0.29	2
	3026HR-2L20	2	26	20	35	200	5.5	0.47	1
	3026HR-3S20	3	26	20	35	115	5.5	0.28	2
	3026HR-3L20	3	26	20	35	200	5.5	0.47	1
	3026HR-2S25	2	26	25	35	115	5.5	0.37	2
	3026HR-2L25	2	26	25	35	200	5.5	0.68	1
	3026HR-3S25	3	26	25	35	115	5.5	0.37	2
	3026HR-3L25	3	26	25	35	200	5.5	0.68	1
	3032HR-3S25	3	32	25	42	125	5.5	0.48	2
	3032HR-3L25	3	32	25	42	200	5.5	0.74	1
	3032HR-4S25	4	32	25	42	125	5.5	0.48	2
	3032HR-4L25	4	32	25	42	200	5.5	0.74	1
	3032HR-4S32	4	32	32	42	125	5.5	0.68	2
	3032HR-4L32	4	32	32	42	200	5.5	1.13	1
	3033HR-3S25	3	33	25	42	125	5.5	0.49	2
	3033HR-3L25	3	33	25	42	200	5.5	0.75	1
	3033HR-4S25	4	33	25	42	125	5.5	0.49	2
	3033HR-4L25	4	33	25	42	200	5.5	0.75	1
	3033HR-4S32	4	33	32	42	125	5.5	0.70	2
	3033HR-4L32	4	33	32	42	200	5.5	1.14	1
3040HR-4S32	4	40	32	45	130	5.5	0.83	2	
3040HR-4L32	4	40	32	45	200	5.5	1.24	1	
3040HR-5S32	5	40	32	45	130	5.5	0.83	2	
3040HR-5L32	5	40	32	45	200	5.5	1.24	1	

Available Inserts

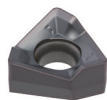

XNKT-MM

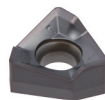

XNKT-ML

Designation	Cermet		Coated								Uncoated			
	CN2000	CN30	NCM325	NC5330	PC3500	PC3600	PC3545	PC3530	PC6510	PC5300	PC5400	A30	G10E	H01
XNKT 060405PNER-ML						●			●	●	●			
060405PNSR-MM						●			●	●	●			

Parts

Specification	Screw	Wrench
Ø20 ~ Ø40	FTNA0306	TW09S

RM3PS4000



AA 90°
 · AR : 5°
 · RR : -11°~7°

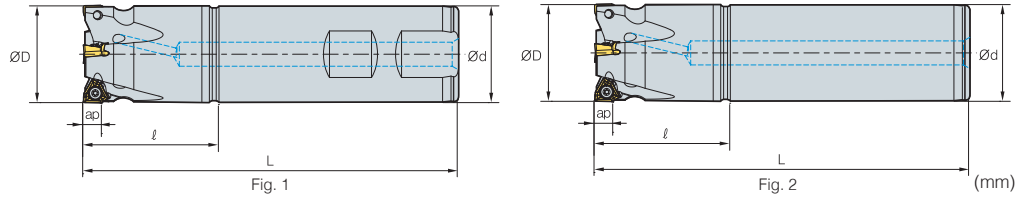

Designation		⊙	ØD	Ød	ℓ	L	ap	kg	Fig.
RM3PS	4032HR-3S32	3	32	32	42	125	8	0.67	2
	4032HR-3L32	3	32	32	42	200	8	1.11	1
	4033HR-3S32	3	33	32	42	125	8	0.68	2
	4033HR-3L32	3	33	32	42	200	8	1.13	1
	4040HR-3S32	3	40	32	42	130	8	0.8	2
	4040HR-3L32	3	40	32	42	200	8	1.21	1
	4040HR-4S32	4	40	32	42	130	8	0.81	2
	4040HR-4L32	4	40	32	42	200	8	1.22	1
	4050HR-4S32	4	50	32	42	135	8	0.99	2
	4050HR-4L32	4	50	32	42	200	8	1.38	1
	4050HR-4S40	4	50	40	42	135	8	1.32	2
	4050HR-4L40	4	50	40	42	200	8	1.94	1
	4050HR-5S32	5	50	32	42	135	8	1.02	2
	4050HR-5L32	5	50	32	42	200	8	1.4	1
	4050HR-5S40	5	50	40	42	135	8	1.35	2
	4050HR-5L40	5	50	40	42	200	8	1.96	1
	4063HR-5S32	5	63	32	42	135	8	1.31	2
	4063HR-5L32	5	63	32	42	200	8	1.7	1
	4063HR-5S40	5	63	40	42	135	8	1.64	2
	4063HR-5L40	5	63	40	42	200	8	2.25	1
4063HR-6S32	6	63	32	42	135	8	1.31	2	
4063HR-6L32	6	63	32	42	200	8	1.7	1	
4063HR-6S40	6	63	40	42	135	8	1.64	2	
4063HR-6L40	6	63	40	42	200	8	2.26	1	

Available Inserts



XNCT-MA



XNKT-ML



XNKT-MM

Designation	Cermet		Coated									Uncoated		
	CN2000	CN30	NCM325	NC5330	PC3500	PC3600	PC3545	PC3530	PC6510	PC5300	PC5400	A30	G10E	H01
XNCT 080504PNFR-MA														
080508PNFR-MA														
080512PNFR-MA														
080520PNFR-MA														
XNKT 080508PNFR-ML						●			●	●	●			
080508PNFR-MM						●			●	●	●			
080512PNFR-ML														
080512PNFR-MM														
080516PNFR-ML														
080516PNFR-MM														
080520PNFR-ML														
080520PNFR-MM														

Parts

Specification	Screw	Wrench
Ø32 ~ Ø63	FTNA0408	TW15



Holystar B/D, 1350, Nambusunhwan-ro, Geumcheon-gu, Seoul, 08536, Korea
 Tel : +82-2-522-3181 Fax : +82-2-522-3184, +82-2-3474-4744 Web : www.korloy.com E-mail : export@korloy.com

KORLOY AMERICA

620 Maple Avenue, Torrance, CA 90503, USA
 Tel : +1-310-782-3800 Toll Free : +1-888-711-0001 Fax : +1-310-782-3885
 www.korloyamerica.com E-mail : sales@korloy.us

KORLOY INDIA

Plot NO.415, Sector 8, IMT Manesar, Gurgaon 122051, Haryana, INDIA
 Tel : +91-124-4391790 Fax : +91-124-4050032
 www.korloyindia.com E-mail : sales.kip@korloy.com

KORLOY EUROPE

Gablonz Str. 25-27, 61440 Oberursel, Germany
 Tel : +49-6171-277-83-0 Fax : +49-6171-277-83-59
 www.korloyeurope.com E-mail : sales@korloyeurope.com

KORLOY BRASIL

Av. Aruana 280, conj.12, WLC, Alphaville, Barueri,
 CEP06460-010, SP, Brasil
 Tel : +55-11-4193-3810 E-mail : vendas@korloy.com